

Technische Daten: Art.-Nr.: 350 180

Wandaußenmaß: 395 x 366 cm

Bohlenstärke: 70 mm



Kontrolliert durch:

Achtung: Alle angegebenen Maße sind ca.-Maße!

3D-Darstellung Art.-Nr. 350 180

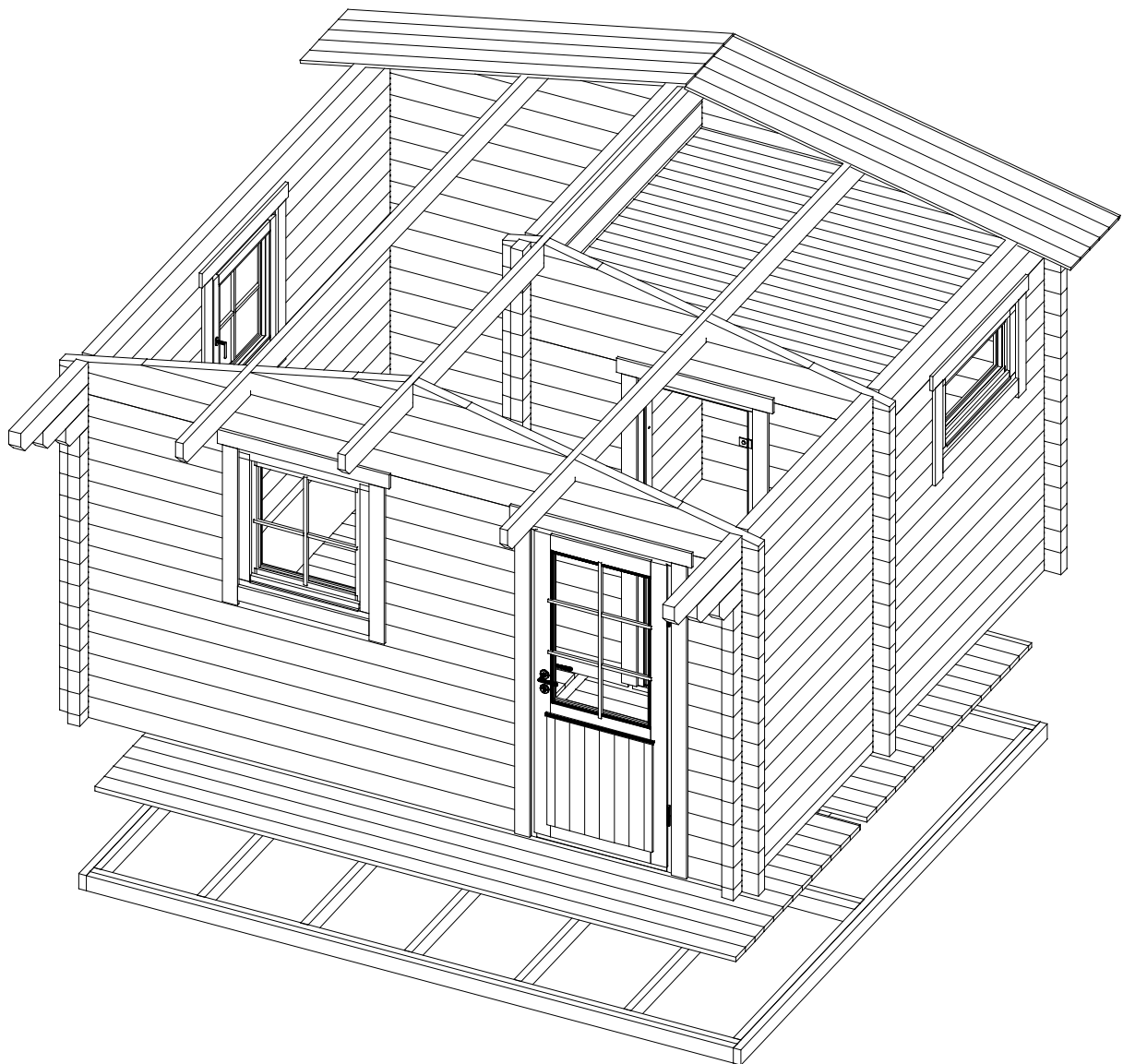

Grundriss

Art.-Nr. 350 180

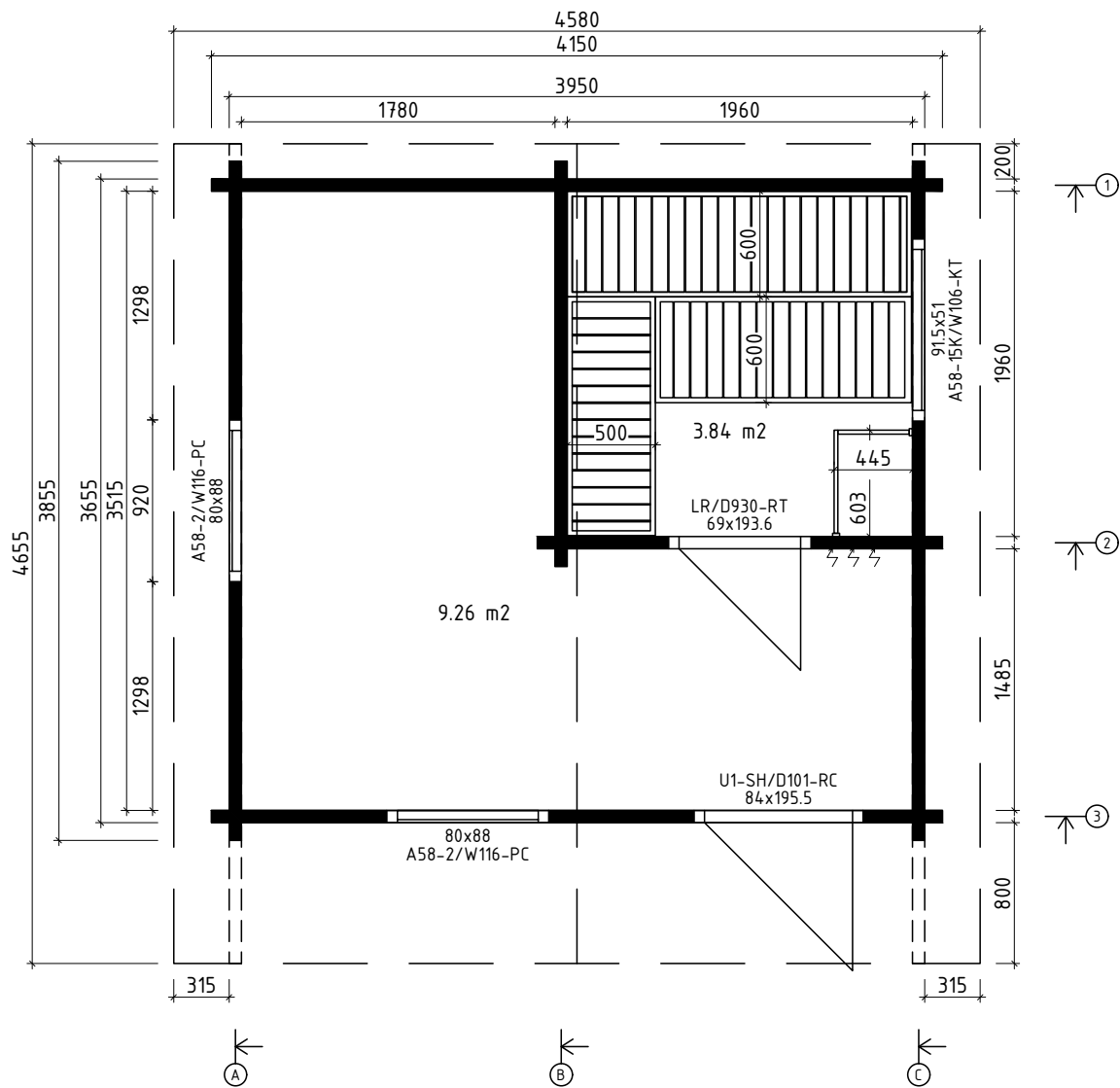

- * Fenster und Türen sind mit Sprossen
- ↘ - Bohrung für elektrische Kabel
- Q4** - Qualitätsklasse für Fenster und Türen





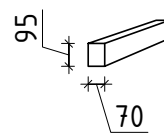
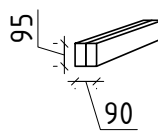
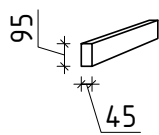
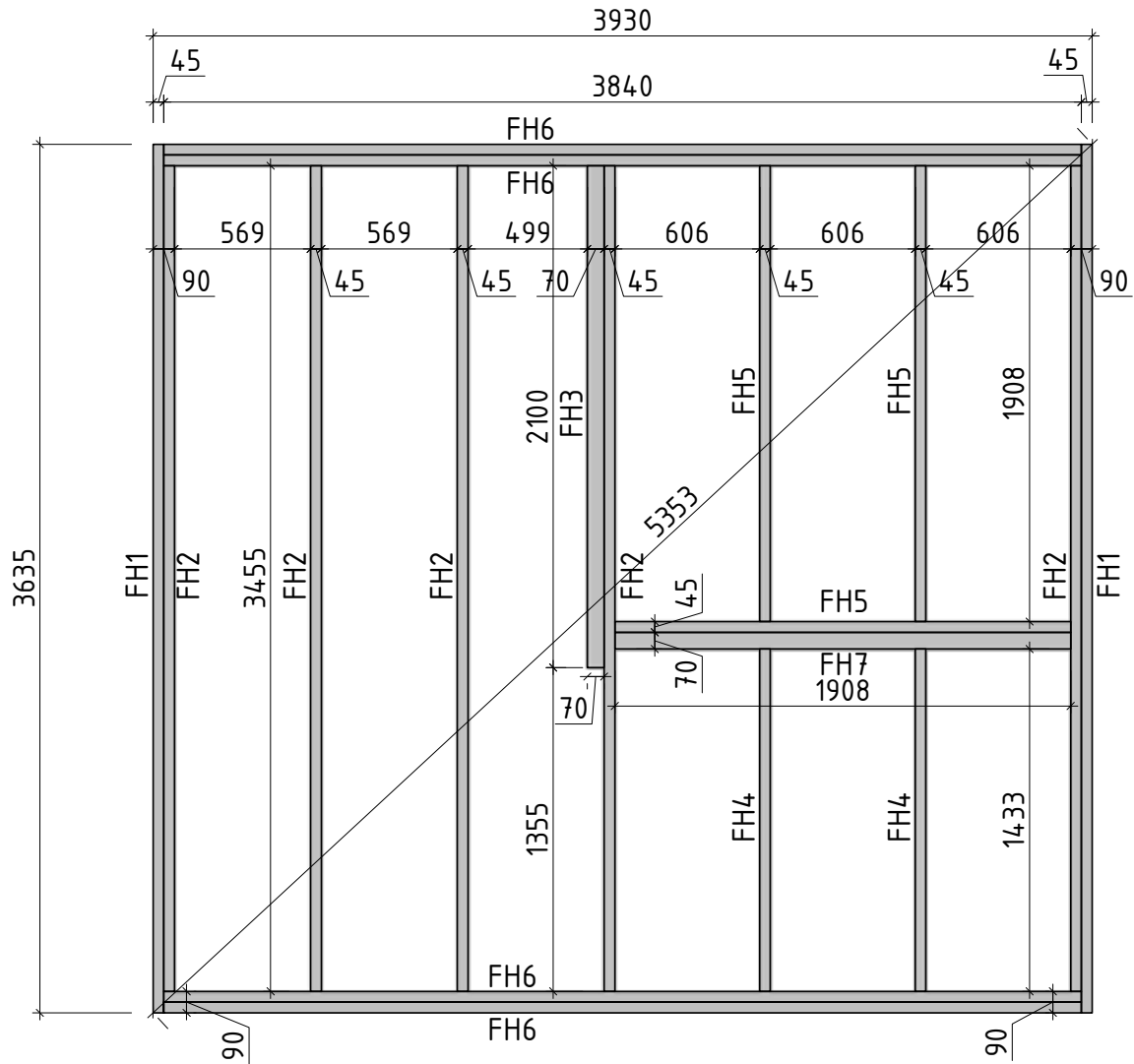

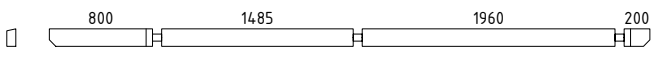
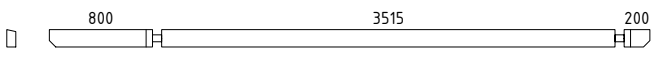
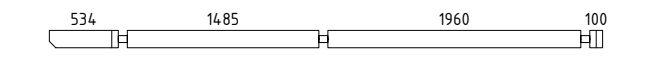
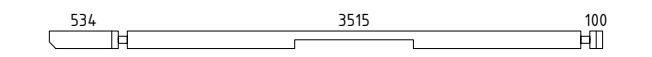
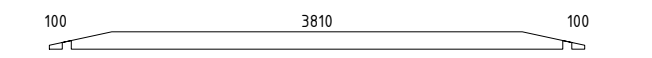
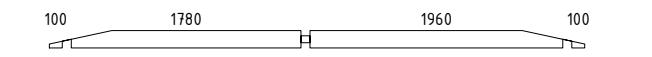
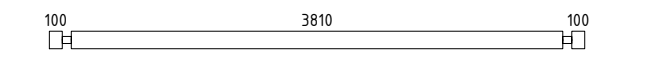
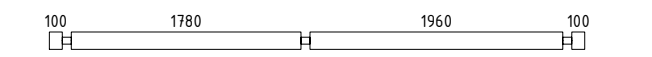
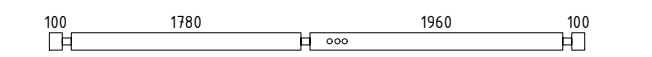

Lagerholzplan und Fundamentplan Art.-Nr. 350 180

Wir empfehlen als Fundament für Ihr Gartenhaus eine vollflächig festgegründete, gepflasterte oder betonierte Fläche.
Wahlweise ist auch ein Punkt- oder Streifenfundament möglich.

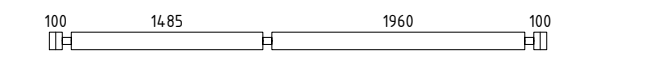
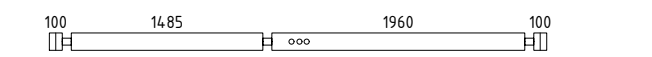

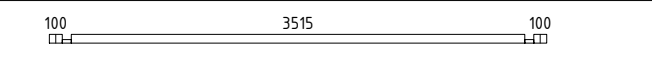
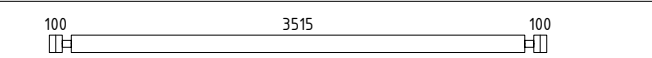

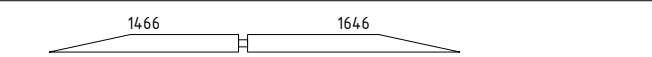
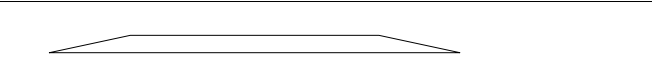
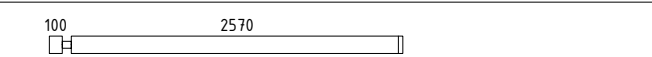

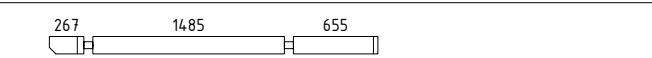
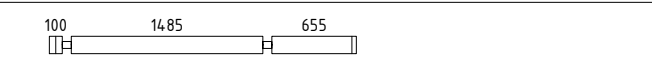
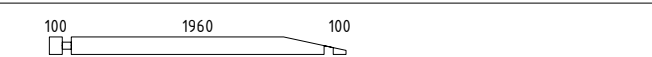
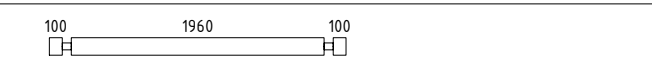

Teileliste 1

Art.-Nr. 350 180

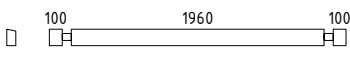
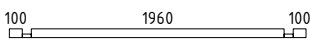
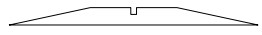
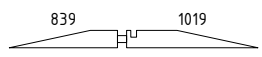
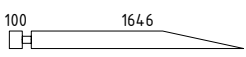
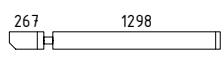
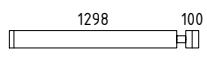
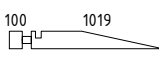
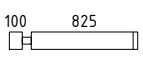
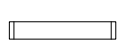
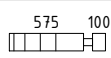
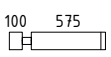
Pos		Stck.	Profil (mm)	Länge (mm)
	Achtung! Die Giebelbohlen können teilweise schon vormontiert sein! Bitte beachten - diese erscheinen nicht ganz so wie in der Teileliste beschrieben.			
001		1	70x135	4655
002		1	70x135	4655
003		1	70x135	4289
004		1	70x135	4289
005		1	70x135	4150
006		1	70x135	4150
007		1	70x135	4150
008		14	70x135	4150
009		2	70x135	4150
010		1	70x68	3855
011		8	70x135	3855
012		1	70x135	3855
013		1	70x135	3855
014		1	70x68	3855
015		7	70x135	3855
016		1	70x135	3855
017		1	70x135	3182
018		1	70x135	3182
019		7	70x135	2740
020		1	70x135	2740
021		1	70x135	2547
022		3	70x135	2380
023		1	70x135	2300
024		19	70x135	2300

Teileliste 2

Artikel-Nr.: 350 180

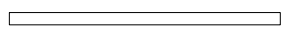
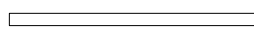
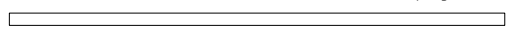
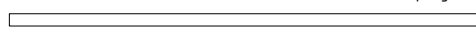
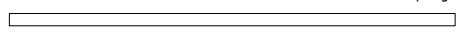
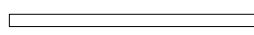
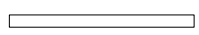
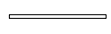
Pos		Stck	Profil (mm)	Länge (mm)
025		1	70x128	2300
026		1	70x68	2300
027		1	70x135	1927
028		1	70x135	1927
029		1	70x135	1816
030		1	70x135	1635
031		11	70x135	1468
032		1	70x135	1189
033		7	70x135	995
034		7	70x135	825
035		14	70x135	745
036		16	70x135	745
037		15	70x135	450
038		4	70x135	440
039		4	70x67	314
040		1	70x67	314
041		1	70x67	203
FH3	FUNDAMENTHÖLZER (imprägniert) 	1	70x95	2100
FH7	FUNDAMENTHÖLZER (imprägniert) 	1	70x95	1908
FH6	FUNDAMENTHÖLZER (imprägniert) 	4	45x95	3840
FH1	FUNDAMENTHÖLZER (imprägniert) 	2	45x95	3635
FH2	FUNDAMENTHÖLZER (imprägniert) 	5	45x95	3455
FH5	FUNDAMENTHÖLZER (imprägniert) 	3	45x95	1908
FH4	FUNDAMENTHÖLZER (imprägniert) 	2	45x95	1433
HS1	HOLZSCHWELLE (unter der Saunatür) 	1	75x28	750











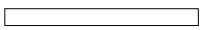
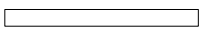

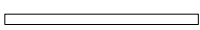



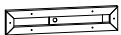

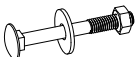



Teileliste 3

Artikel-Nr.: 350 180

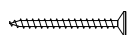
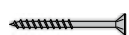
Pos		Stck	Profil (mm)	Länge (mm)	
PF2		2	44x145	4655	
PF1		1	44x145	4655	
	DACHBRETT	84+1	113x18	2340	
	FUSSBODENBRETT	14+1	113x28	3805	
	FUSSBODENBRETT	18	113x28	1955	
	FUSSBODENBRETT	18	113x28	1775	
	DECKENLEISTEN	✓	15x28	28.0lfm	
	FUSSBODENLEISTEN	✓	14x55	24.0lfm	
G02-1	GIEBELBRETT 18x120	12,1° ✓	4	18x120	2420
G06-1	GIEBELDECKLEISTEN 18x58	✓	4	18x58	2420
T01-1	TRAUFBRETT 18x95		2	18x95	4655
T06-1	TRAUFBRETT 18x40	✓		18x40	10.0lfm
GS	Giebelsegment		2		
SH	Schlaghölzer		3		
TL70-1	T-LEISTE 70		2	45x70	490
TL70-2	T-LEISTE 70		2	45x70	760
TL70-3	T-LEISTE 70		2	45x70	895
TL70-4	T-LEISTE 70		4	45x70	1975
	DECKENISOLATION		2 Elemente	ca 1950x975	
SA16-1	SAUNA - Bänke Zwischenstück		1	40x300	1955
SA15-1	SAUNA - Rücklehne		2	40x250	1860
SA02-1	SAUNA - Saunabank 50cm		1	500x90	1355
SA01-1	SAUNA - Saunabank 60cm		2	600x90	1955
SA20-1	SAUNA - Trägleiste für Deckenisolation	✓	4	35x35	2000

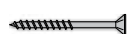
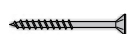
Teileliste 4

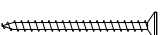
Art.-Nr. 350 180

Pos			Stck	Profil (mm)	Länge (mm)	
SA11-1	SAUNA - Stützpfeiler für Saunabänke		✓	1	44x65	500
SA11-2	SAUNA - Stützpfeiler für Saunabänke		✓	2	44x65	1000
SA10-1	SAUNA - Trägleiste für Saunabänke		✓	3	30x40	600
SA10-2	SAUNA - Trägleiste für Saunabänke		✓	2	30x40	1200
SA37	SAUNA - Bodenrost			1		
SA30	SAUNA - Heizung Umbau (set 1)			1		
SA35	SAUNA - Kopfstütze			2		
SA36	SAUNA - Luftschieber			3		
SA25-1	SAUNA - Dichtungsband für Deckenisolationselemente		✓	1		8,0 lfm
SS023	Schloßschrauben M8x70 Mutter M8 U-Scheibe Ø25 - Befestigung für Saunabänke			2		
KL1	Gewindestange M8			4		2000
KL2	Gewindestange M8			4		258
KV M UT M8	Mutter M8			8		
KV S EIB M8X25	U-Scheibe M8 Ø25			8		
KV MU TJ M8	Befestigungsmutter M8			4		
NG04	NÄGEL 2.5x50 Dachbretter			504		
SR32	SCHRAUBEN 3.0x30 Deckenleisten, Fussbodenleisten Traufenleisten 18x40, Bänke Zwischenstück, Luftschieber			144		
SR37	SCHRAUBEN 3.5x45 Heizung Umbau			18		
SR3547	SCHRAUBEN 3.5x45 C3 Fenster- und Türleisten			112		
SR3547	SCHRAUBEN 3.5x45 C3 Giebelbretter			20		
SR3547	SCHRAUBEN 3.5x45 C3 Giebelleisten			20		
SR3547	SCHRAUBEN 3.5x45 C3 Giebelsegment			4		
SR3547	SCHRAUBEN 3.5x45 C3 Traufenbretter			18		
SR44	SCHRAUBEN 4.0x60 Trägleiste für Saunabänke, Rücklehne Trägleiste für Deckenisolation			62		
SR4257	SCHRAUBEN 4.2x55 C2 28mm Fussbodenbretter			268		

Teileliste 5

Art.-Nr. 350 180

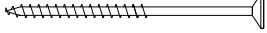
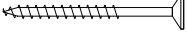
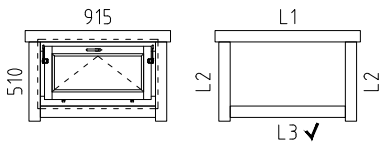
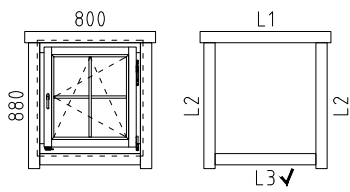
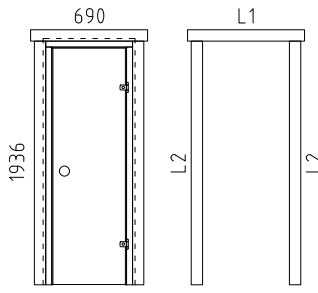
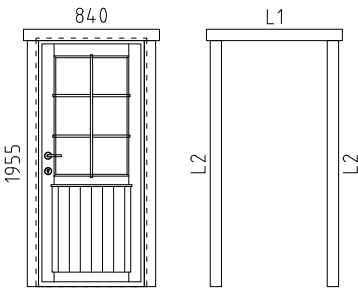
Pos		Stck	Profil (mm)	Länge (mm)
SR57	SCHRAUBEN 5.0x100 Fundamenthölzer 	72		
SR55	SCHRAUBEN 5.0x70 Stützpfeiler für Saunabänke 	10		
Q4 FENSTER	W4-S70K-0XT-09150510	1		
	 <p>A58-15K/W106-KT</p> <p>L1 18x90 L=1155mm 2x L2 18x90 L=630mm 4x L3 18x90 L=915mm 2x ✓</p>			
Q4 FENSTER	W4-S70P-04C-08000880	2		
	 <p>A58-2/W116-PC</p> <p>L1 18x90 L=1040mm 2x L2 18x90 L=1000mm 4x L3 18x90 L=800mm 2x ✓</p>			
Q4 TÜR	D0-L70R-0XT-06901936	1		
	 <p>LR/D930-RT</p> <p>L1 18x90 L=930mm 2x L2 18x90 L=1935mm 4x ✓</p> <p>DIN rechts</p>			
Q4 TÜR	D4-S70R-56C-08401955	1		
	 <p>U1-SH/D101-RC</p> <p>L1 18x90 L=1080mm 2x L2 18x90 L=1955mm 4x ✓</p> <p>DIN rechts</p>			
	✓ - bitte selber anpassen (falls nötig)!			

Wandplan 1 und 2

Art.-Nr. 350 180

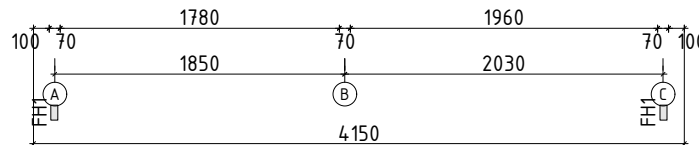
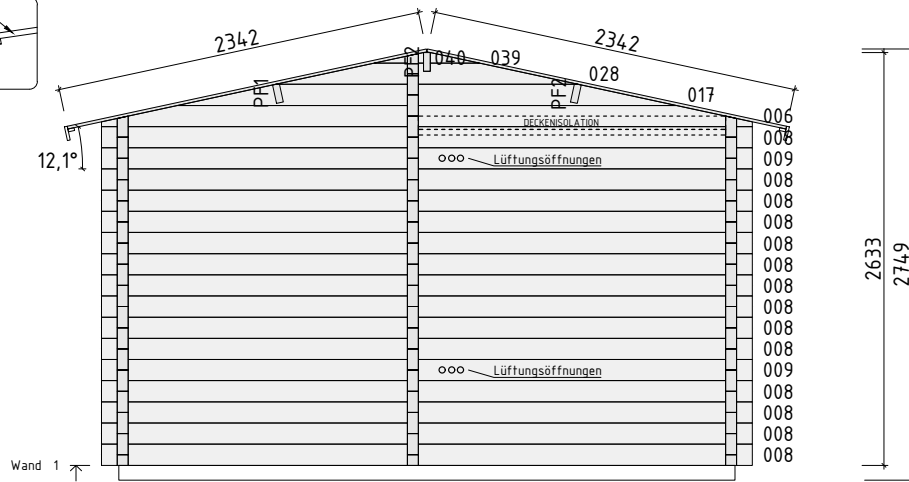
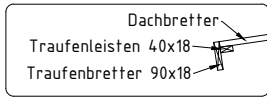

Die Bohlen mit Lüftungsöffnungen können je nach Bedarf höher oder niedriger eingesetzt werden. Bitte achten Sie darauf dass die Lüftungsöffnungen von innen nicht mit der Saunabank bedeckt werden!

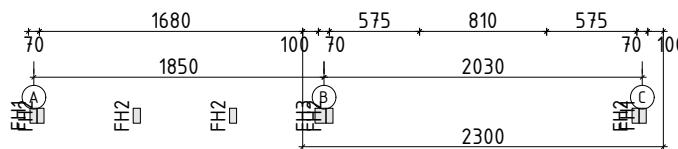
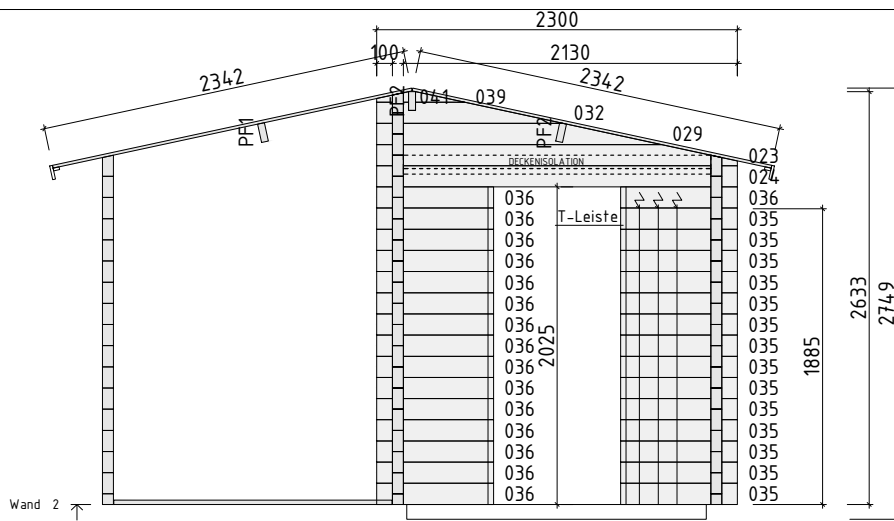

▽ -Bohrung für elektrische Kabel

Wandplan 3 Art.-Nr. 350 180

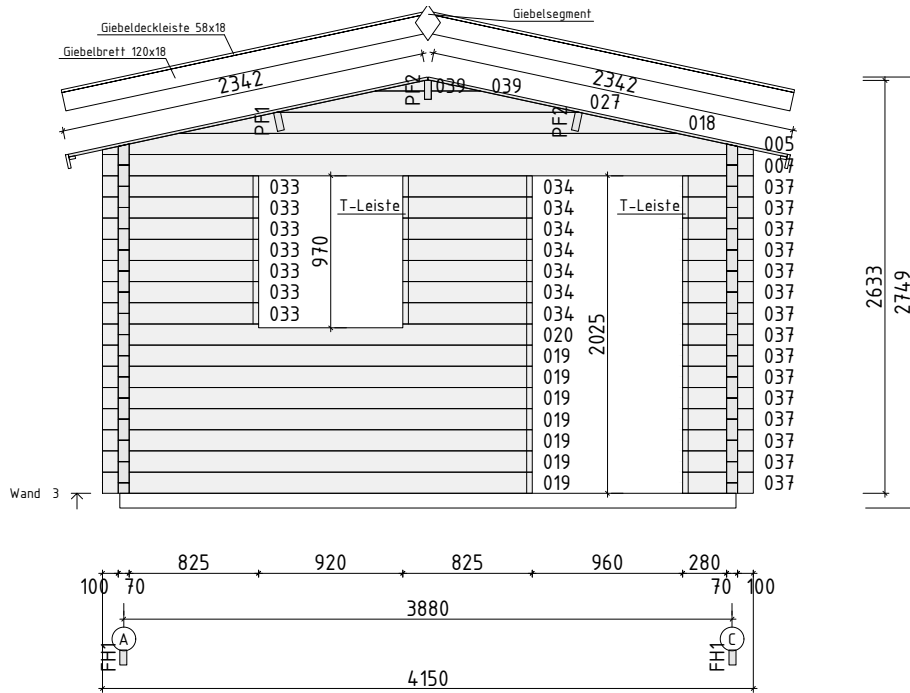

Wandplan C

Art.-Nr. 350 180

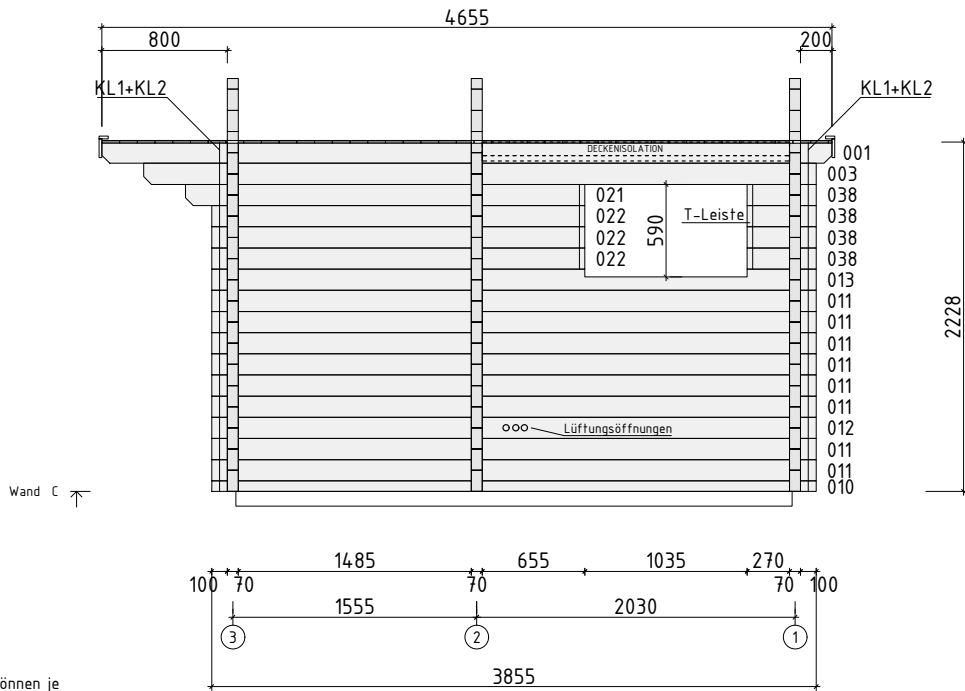

Wand C ↗

Die Bohlen mit Lüftungsöffnungen können je nach Bedarf höher oder niedriger eingesetzt werden. Bitte achten Sie darauf dass die Lüftungsöffnungen von innen nicht mit der Saunabank bedeckt werden!



Montage für T-Leisten (Tür- und Fensterstützen) Art.-Nr. 350 180

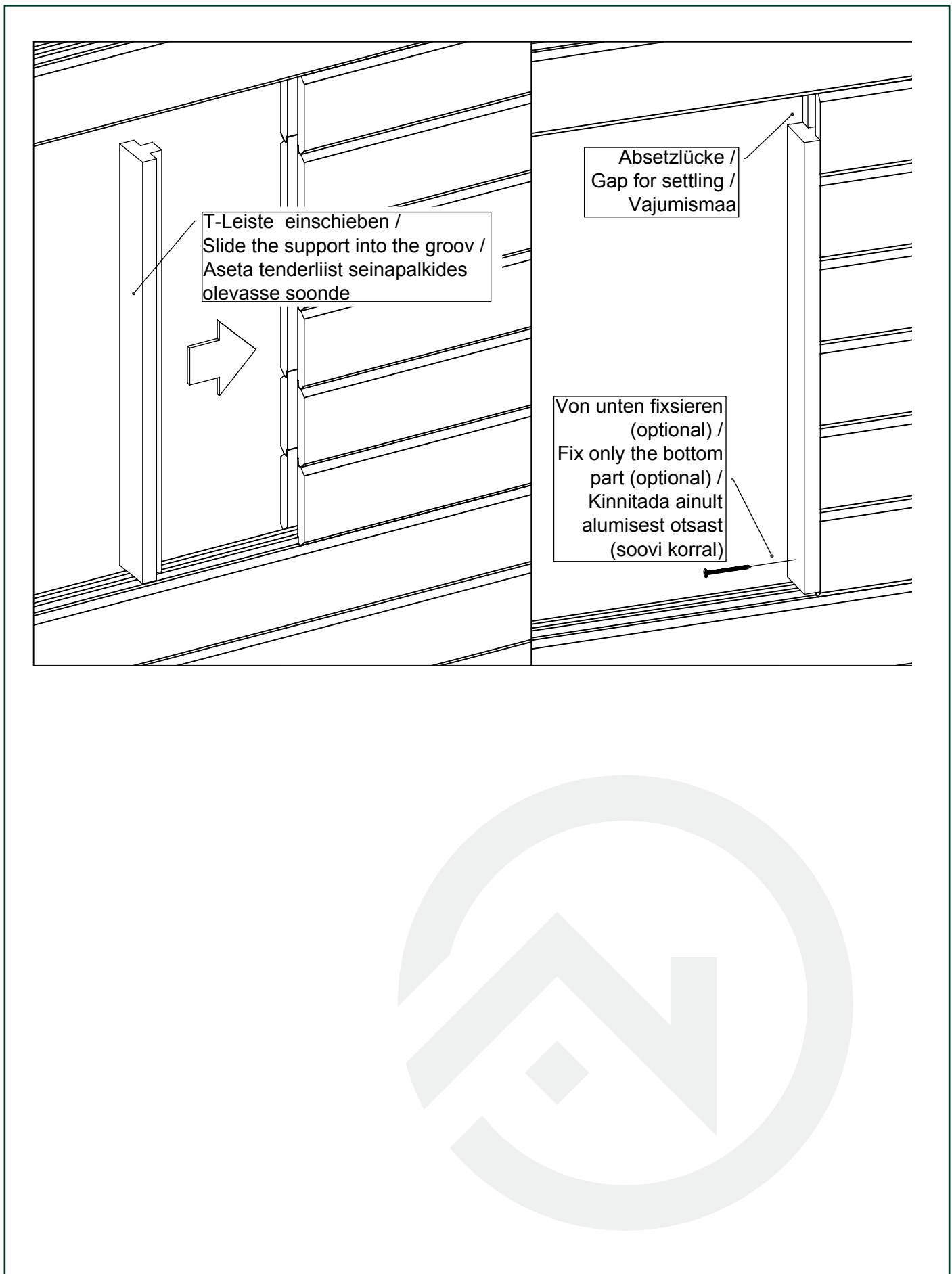

Fenstermontage

Art.-Nr. 350 180

Aken Q4-Q6 - paigaldusjuhised
 Window Q4-Q6 - assembly instructions
 Fenster Q4-Q6 - Montageanleitung

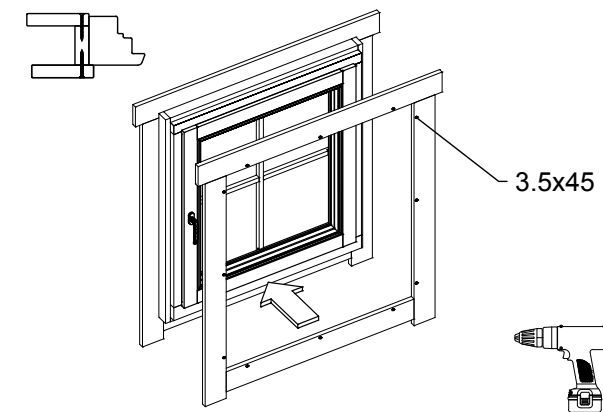
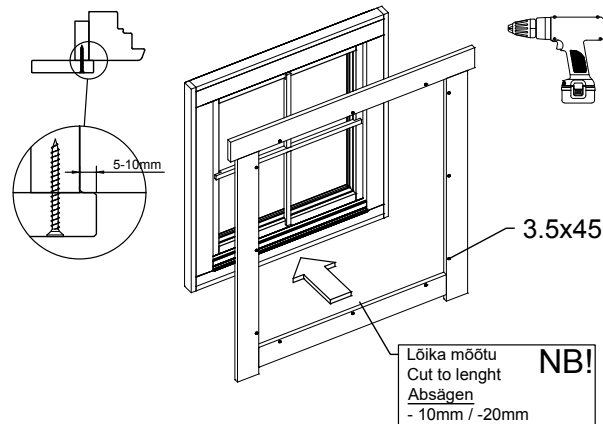
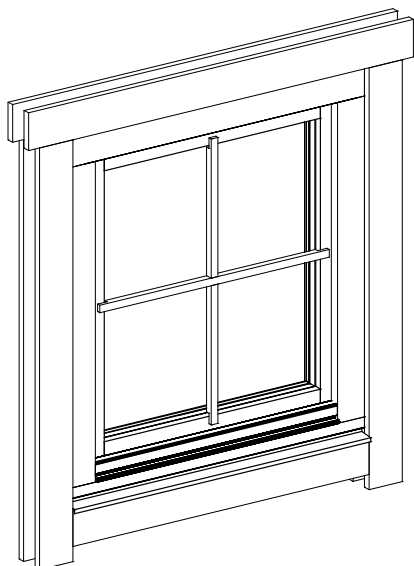

Fensterbankmontage

Art.-Nr. 350 180

Q4

1

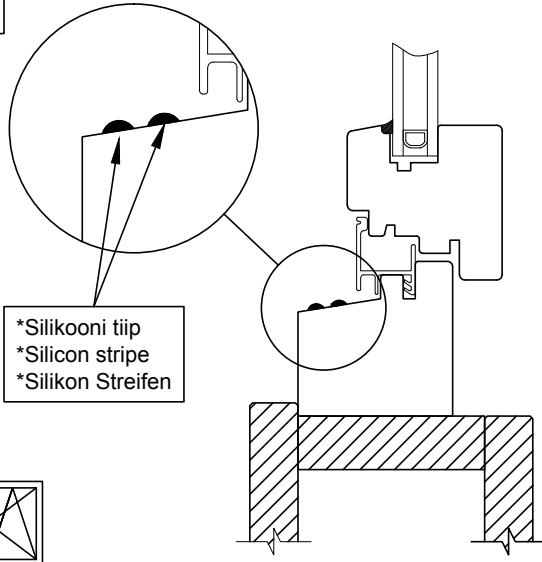

2

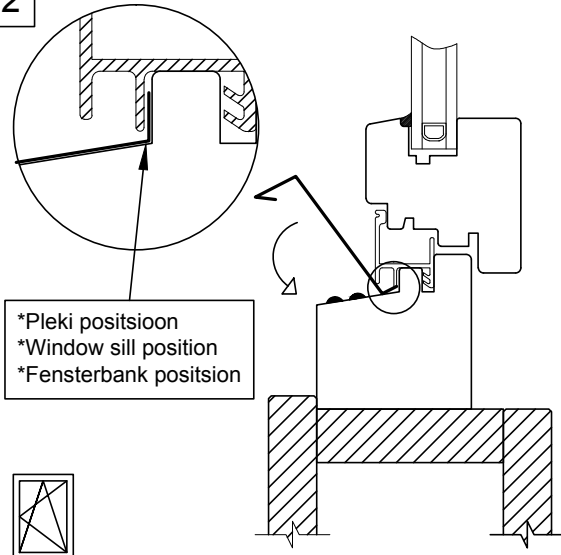

3

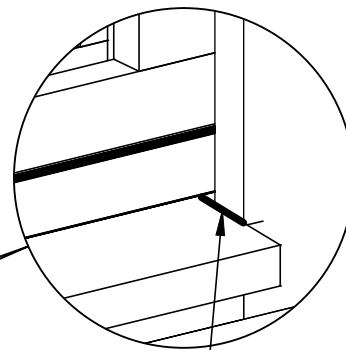
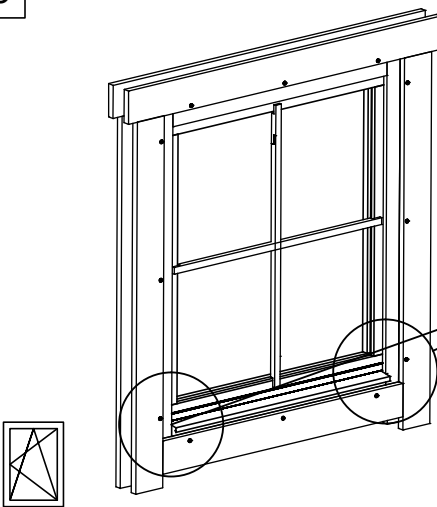

*Silikooni tiip
*Silicon stripe
*Silikon Streifen

1

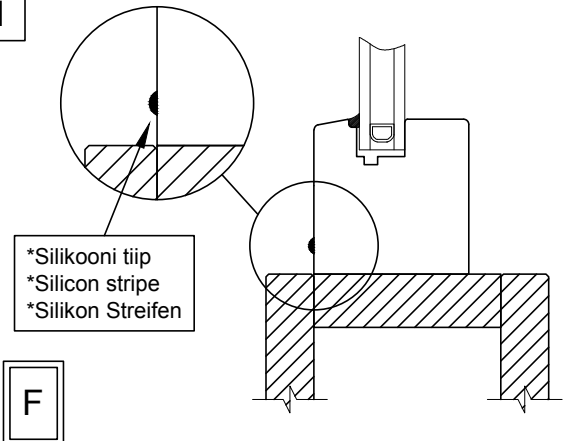

2

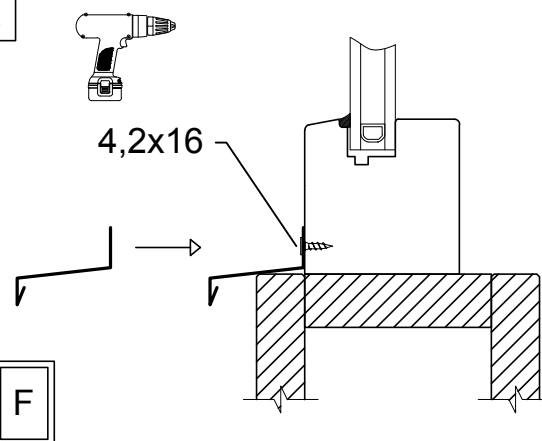

Türmontage

Art.-Nr. 350 180

Ukse montaaž / Tür montage / Door assembly
(GH+ / SH)

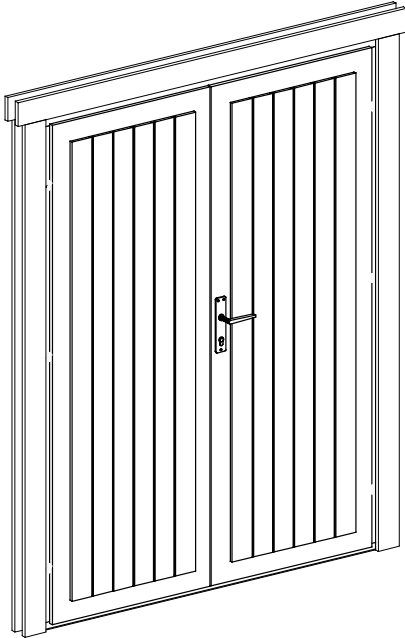

4.5x90

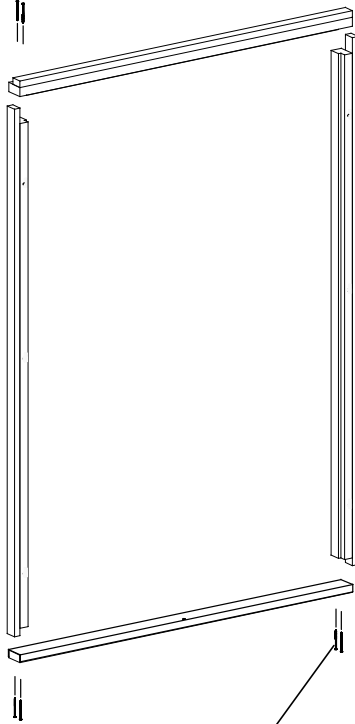

4.5x90

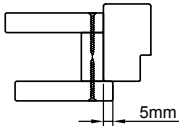

5mm

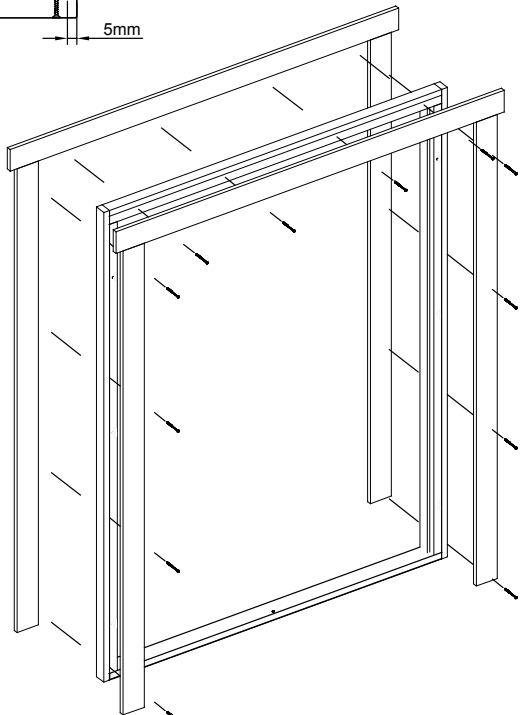

3.5x45

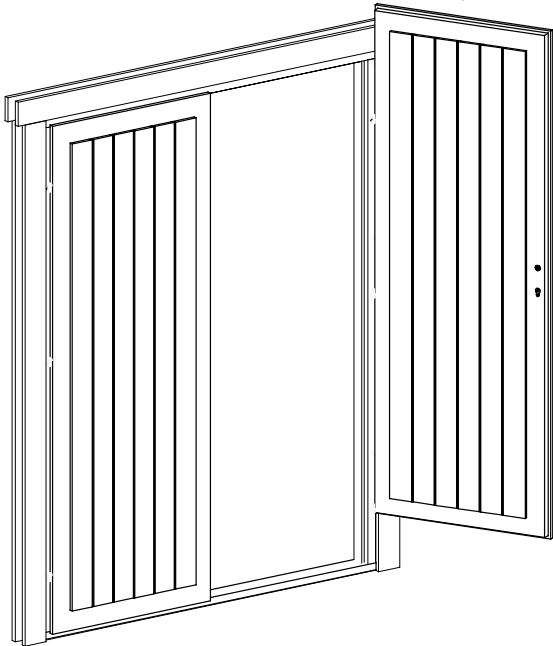

Türmontage

Art.-Nr. 350 180

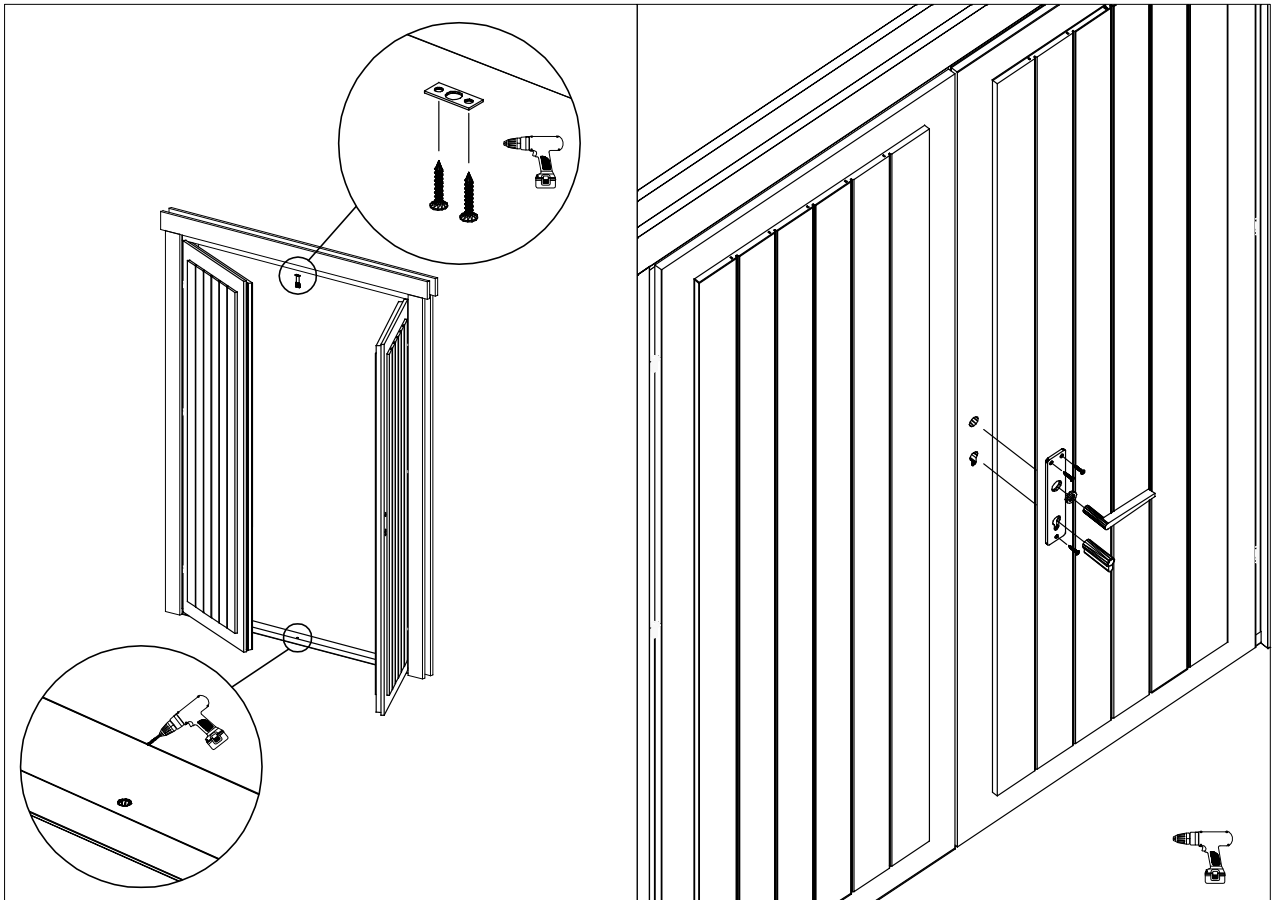

Türmontage

Art.-Nr. 350 180

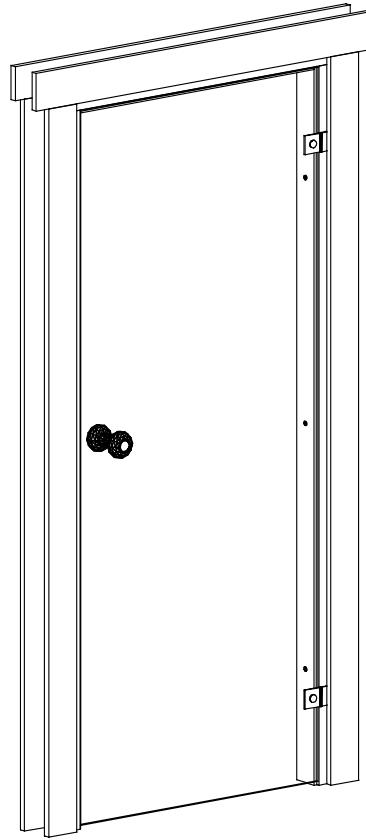

18x90 Blendleisten/
cover strips/piirdeliistud

Rahmenleisten
20x Wandstärke/
frame extensions
20x wall thickness/
laiendusliist
20x seinä paksus

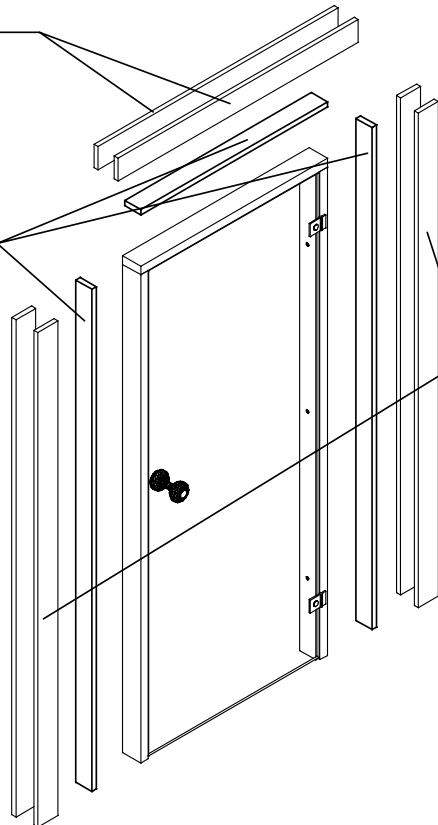

18x90 Blendleisten/
cover strips/piirdeliistud

Türmontage

Art.-Nr. 350 180

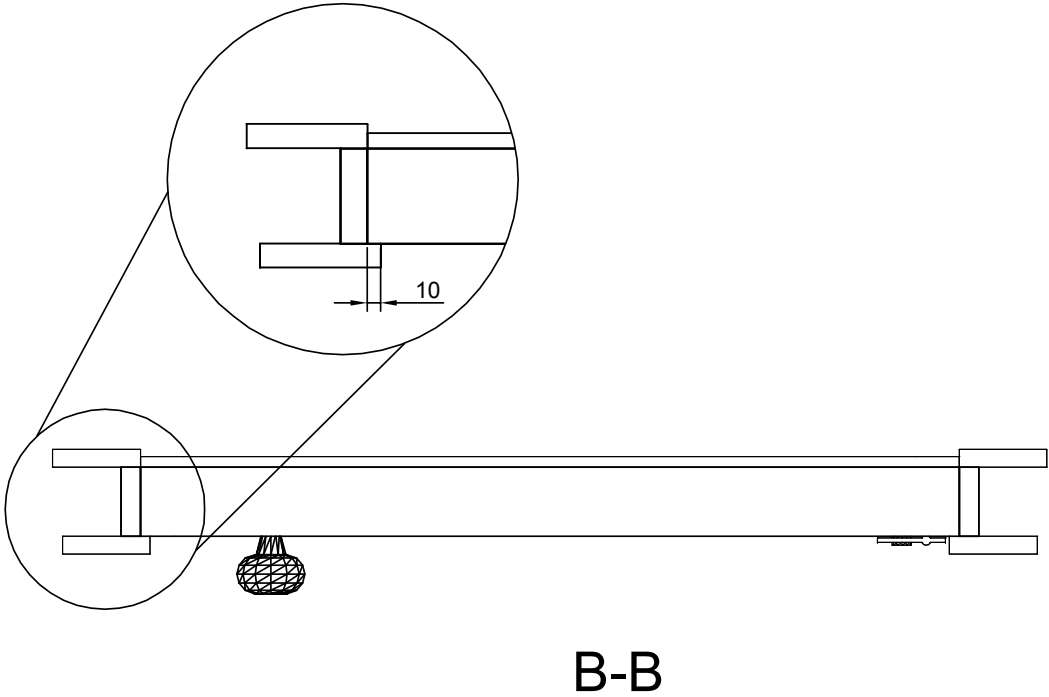
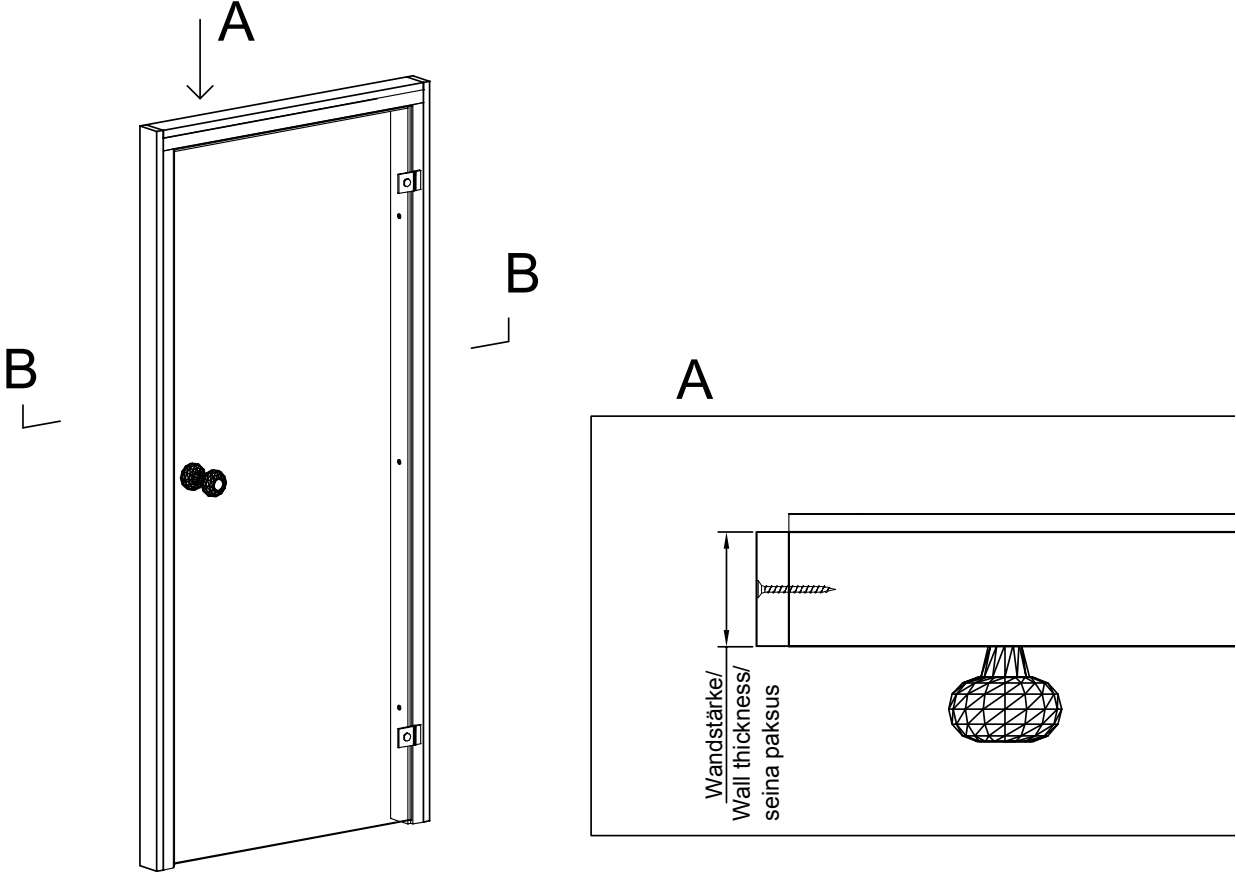

Türmontage

Art.-Nr. 350 180

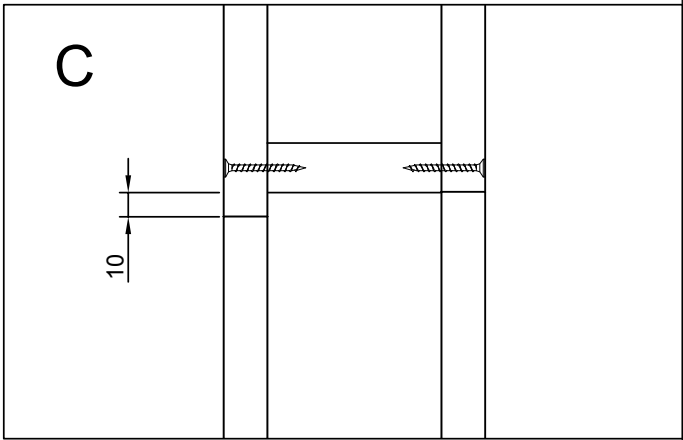
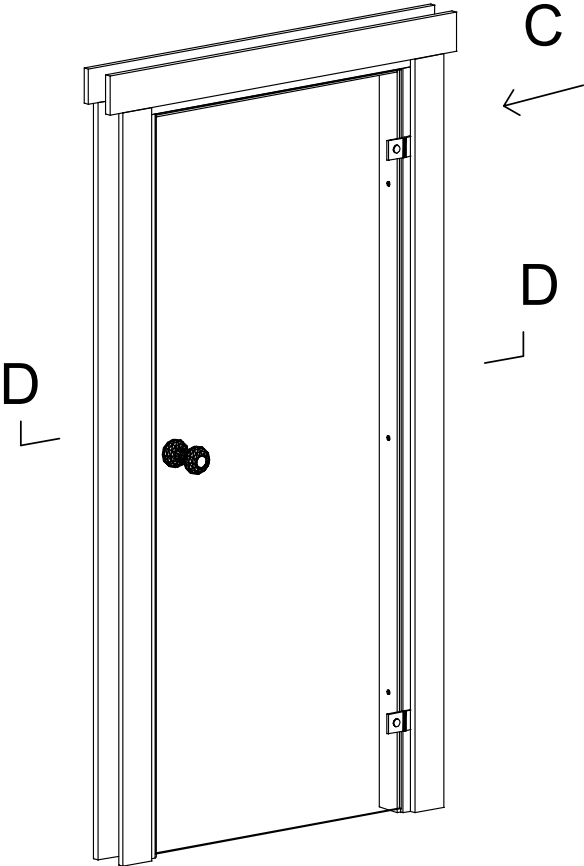

D-D

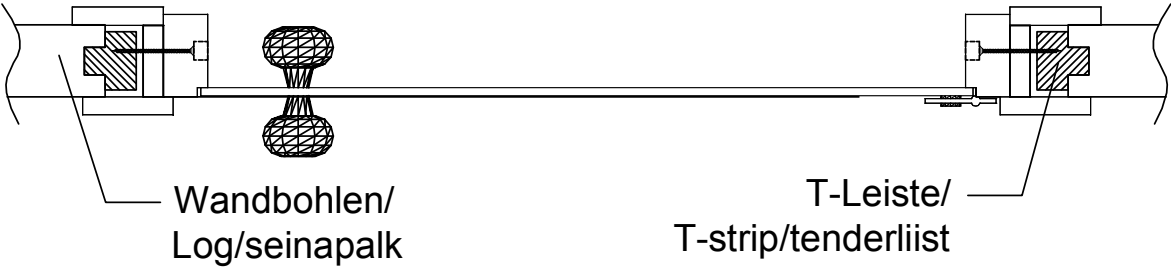

Einsetzen der Saunabänke Art.-Nr. 350 180

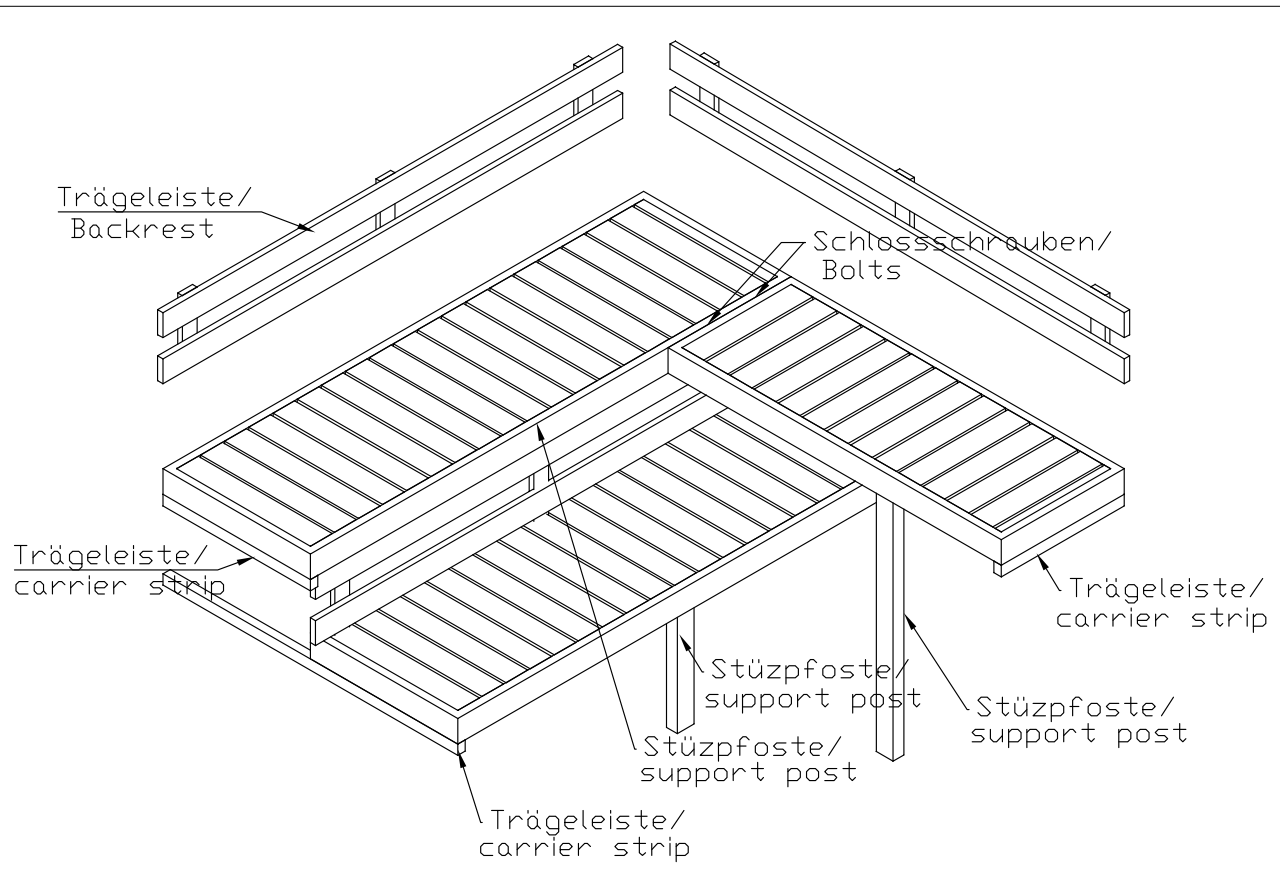

Montage Bänke und Zwischendecke

Art.-Nr. 350 180

