

# Technische Daten: Art.-Nr.: 846020

Wandaußenmaß: 390 x 390 cm

Bohlenstärke: 44 mm



Trondheim 70-D XL

Kontrolliert durch:

Empty box for signature or name.

Achtung: Alle angegebenen Maße sind ca.-Maße!

# 3D-Darstellung und Grundriss 846020

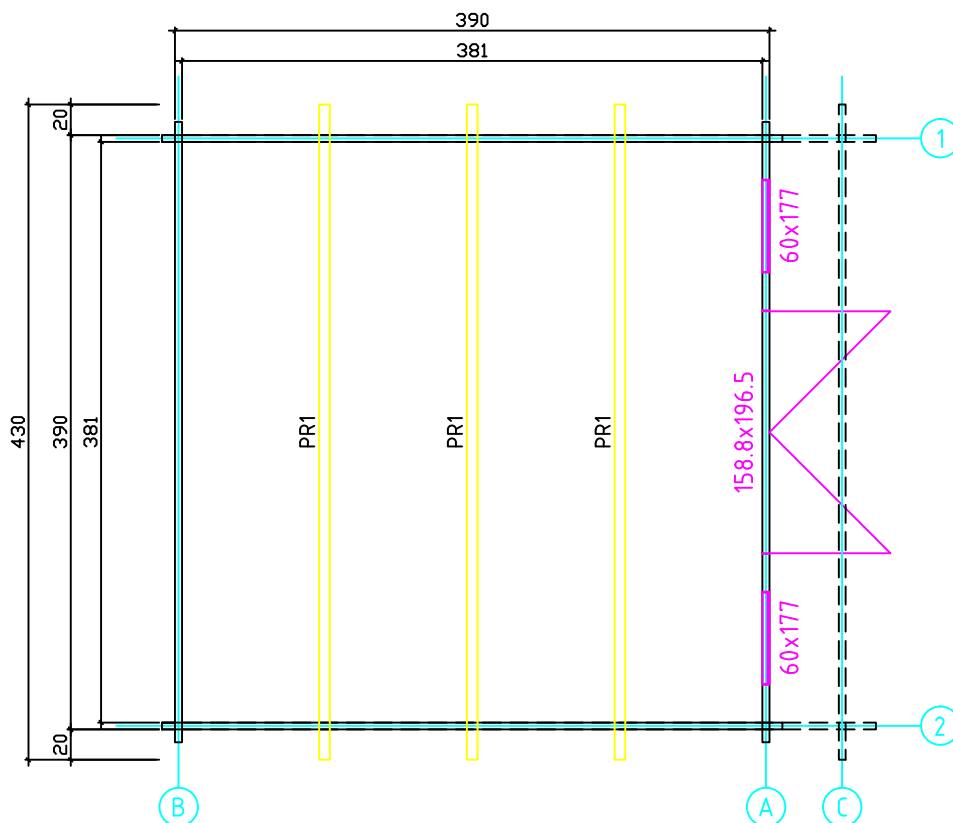
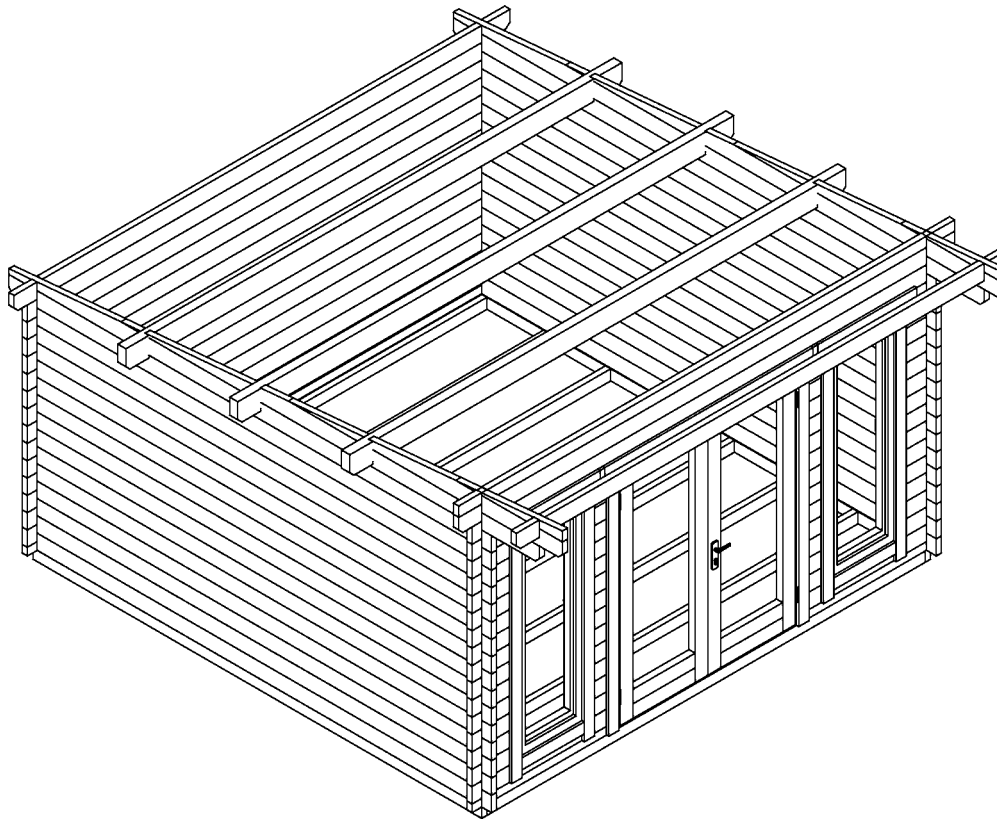





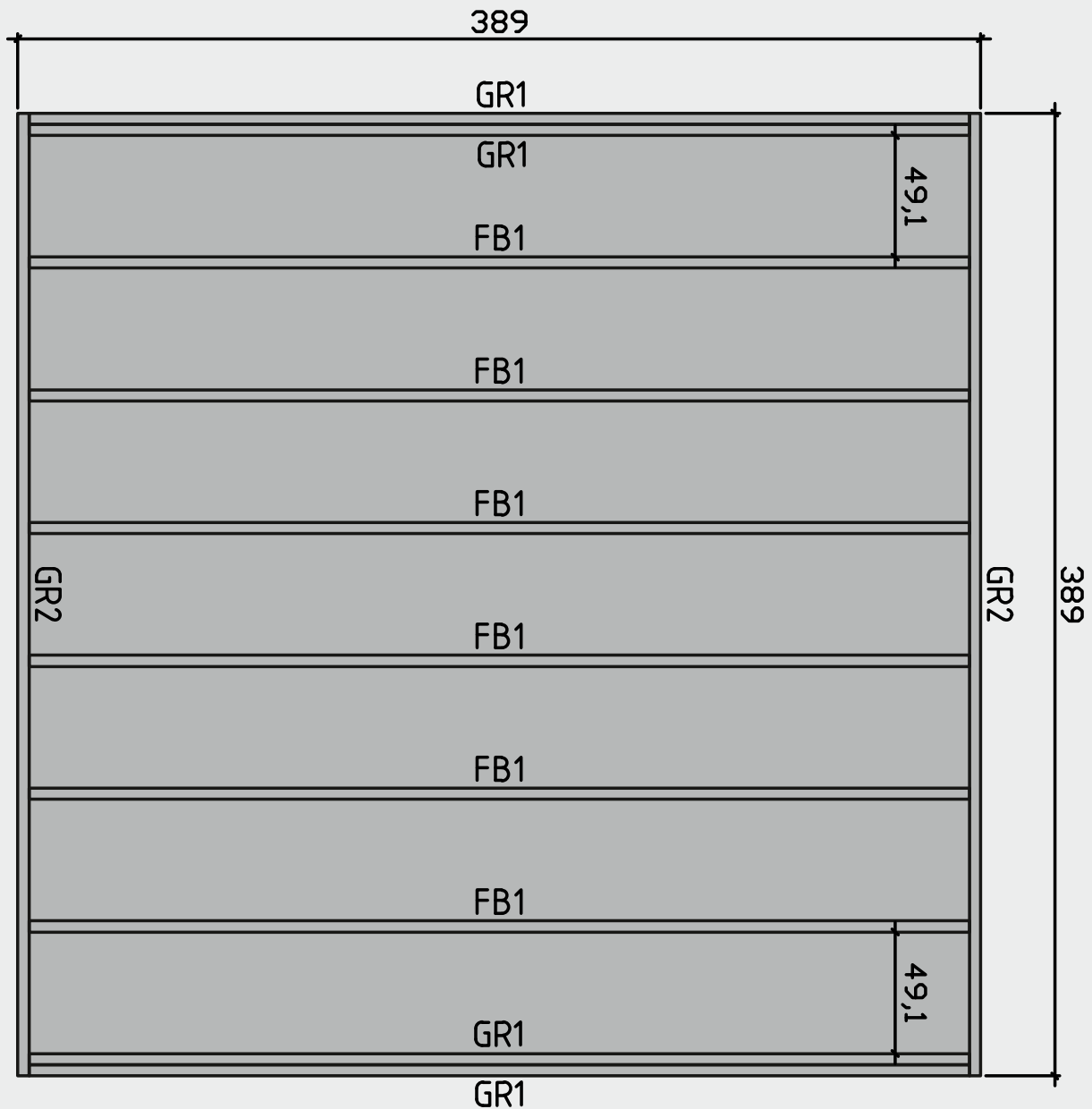





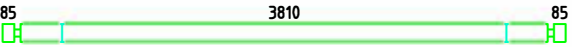

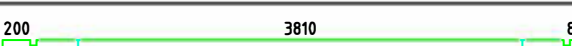





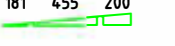

# Lagerholzplan und Fundamentplan 846020

Wir empfehlen als Fundament für Ihr Gartenhaus eine vollflächig festgegründete, gepflasterte oder betonierte Fläche.  
Wahlweise ist auch ein Punkt- oder Streifenfundament möglich.

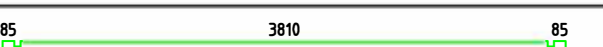

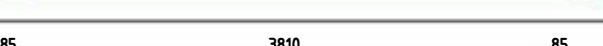
# Teileliste 1

## 846020

Pos				
001		2	45x130	4070
002		2	45x130	4070
003		24	45x130	4070
004		2	45x130	4185
005		2	45x130	1150
006		2	45x130	2975
007		2	45x16	179
008		2	45x103	940
009		2	45x130	2420
010		2	45x60	667
011		2	45x130	1680
012		2	45x83	926
013		2	45x65	1236
014		2	45x130	1236
015		28	45x130	378
016		28	45x130	248
017		15	45x130	4070
018		1	45x130	4300
019		1	45x85	4300
020		1	45x65	4070
021		2	45x130	4300
GR2		2	45x90	3890
GR1		4	45x90	3800
FB1		6	45x90	3800
PR1		3	70x170	4300

# Teileliste 2

## 846020

Pos					
	WINDOW 600x1770			2	
	DOOR 1588x1965			1	
1	Screws/Schrauben/Vis 5x100 mm- For fixing first row of wall logs /Fixierung des ersten Bohlenkranzes/Pour fixer les lames de plancher		6		
2	Nails/Nägel/Clous 2.5x50 - For fixing floorboards/ Befestigung Fussbodenbretter/Pour fixer les lames de plancher		350		
3	Nails/Nägel/Clous 2.5x50 - For fixing roofboards/ Befestigung Dachbretter/Pour fixer les voliges		300		
4	Nails/Nägel/Clous 2.5x50 - For fixing floor edge trims/ Befestigung Fussleisten/Pour fixer les plinthes du plancher		30		
5	Nails/Nägel/Clous 2.5x50 - For fixing roofing felt fillet/ Befestigung giebelabschlussbrett/Pour fixer la latte de finition de la couverture		30		
6	Screws/Schrauben/Vis 2,5x50 mm- For fixing roof side boards and roof edge reinforcement Befestigung Traufenbretter und Traufenleisten Pour fixer les planches de rive et le tasseau de refreont		150		
7	Screws/Schrauben/Vis 2,5x50 mm- For fixing fascia boards and diamonds/ Befestigung Giebelblende und Raute Pour fixer les planches de rive et le diamant				
8	Screws/Schrauben/Vis 2,5x50 mm- For fixing fwindow and door trims/ Befestigung Fenster und türen/ Pour fixer les croisillons des fenetres et des portes				
9	Metal storm Brace/Gewindestange/Tige filetee 8 mm		4		
10	Shim,Nuts/Mutter, U-Scheibe/Ecrou,Rondelle 8 mm For fixing storm braces/ Pour fixer les anti tempete/ Für Sturmleisten Pour fixer les croisillons des fenetres et des portes  Metal storm Brace/Gewindestange/Tige filetee 8 mm KL1 M8 2,44 m 2 Screws 180 8 pcs. KL2 M8 2,18 m 2 Plastic caps 4 pcs.		4/4		

# Teileliste 3

## 846020

POS	ST.	B	H	L	Teileliste
FB1	Vt. spetsi				FUNDMENTHOLZER
F1	14,5m <sup>2</sup>	28		3805	FUSSBODENBRETTER
PR	3	70	170	4300	DACHBALKEN
RB1	20,7m <sup>2</sup>	20		4819	DACHBRETTER
*R1	2	20	140	4340	Traufenbretter
*R2	2	45	45	4300	Traufenbretter
*R3	2	20	140	5020	Giebelabschlussleiste
*R4	2	20	90	5020	Giebelabschlussleiste
DR1 WN1	1 2	1588 600	1965 1770		
*P1	17m	20	40		Fußbodenleiste
*P2	1+1	20	90	3800	Türleiste DR1, Fensterleiste WN1
*P3	6+6	20	90	1945	Türleiste DR1, Fensterleiste WN1
*P4	2+2	20	90	540 570	Fensterleiste WN1
*Wird als Fixlänge geliefert und muss bauseits zugeschnitten werden.					

# Wandplan 1 und 2 846020

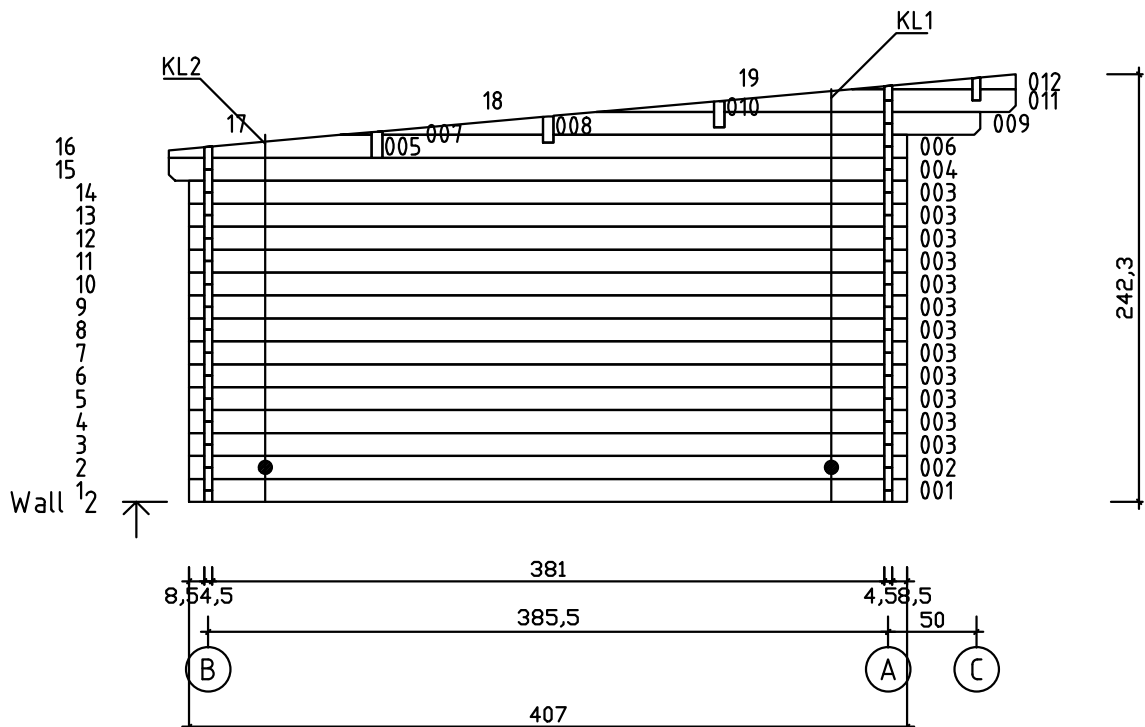
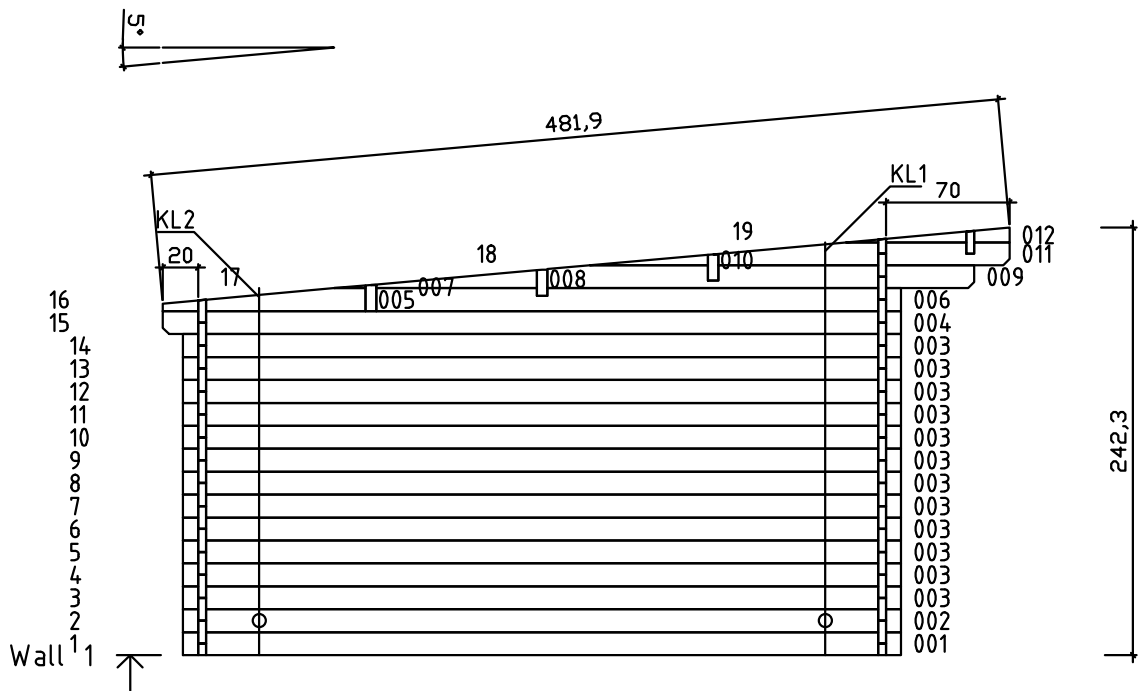

# Wandplan A und B 846020

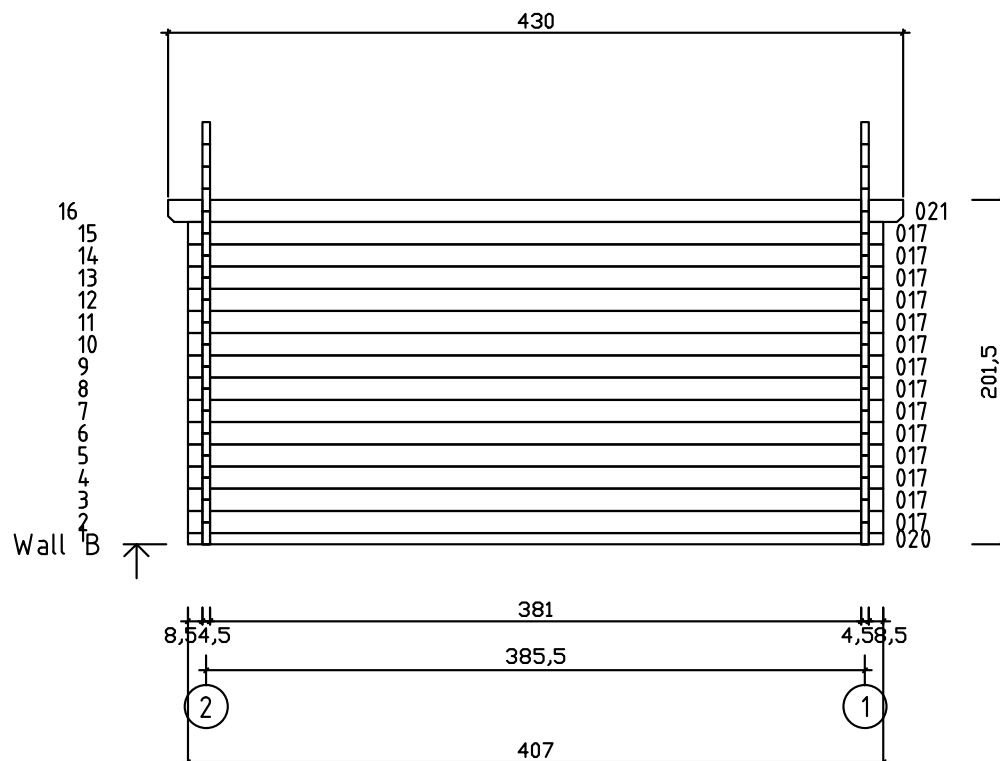
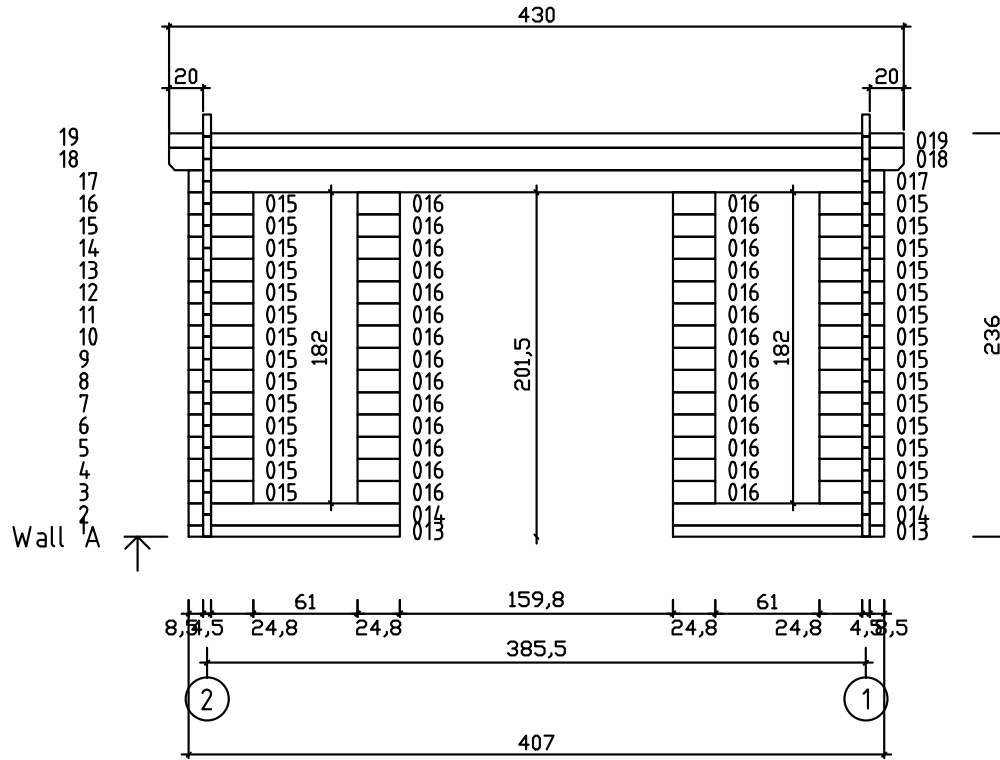



# Wandplan C 846020

## Vorgelagerte Vordachbohle vor Wand A

