

Technische Daten: Art.-Nr.: 870905

Wandaußenmaß: 360 x 300 cm

Bohlenstärke: 70 mm



Trondheim 70-D XL

Kontrolliert durch:

Achtung: Alle angegebenen Maße sind ca.-Maße!

3D-Darstellung und Grundriss 870905

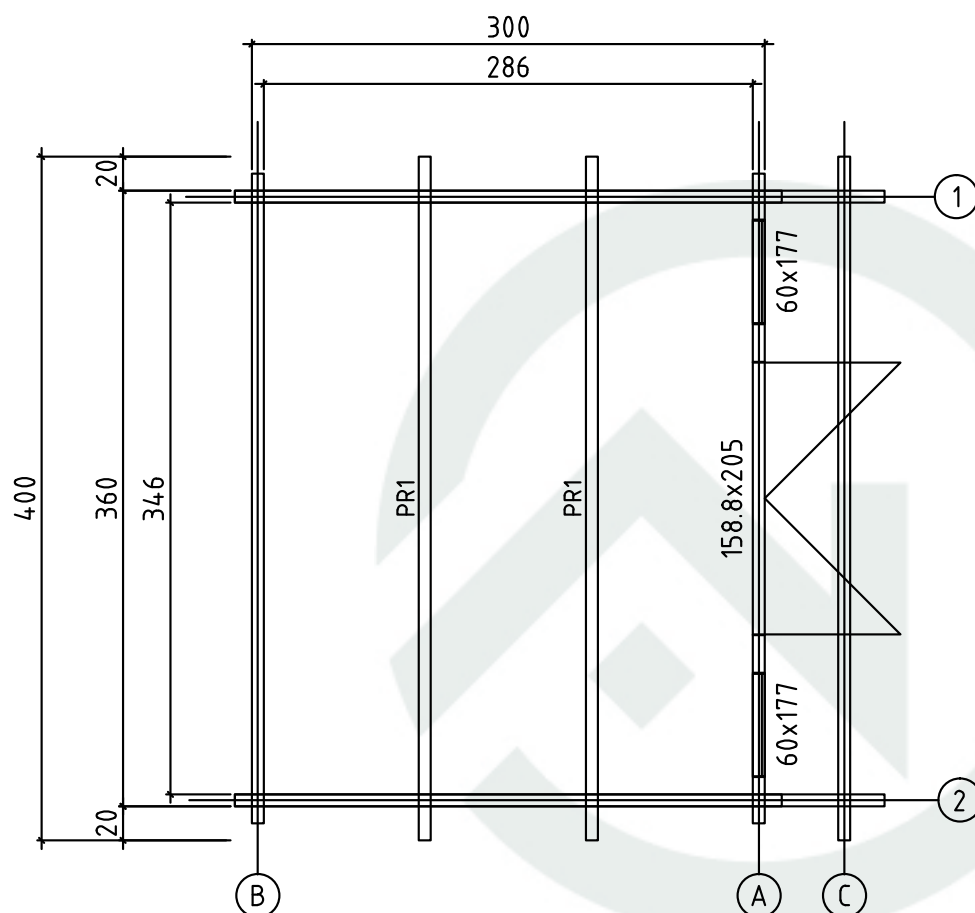
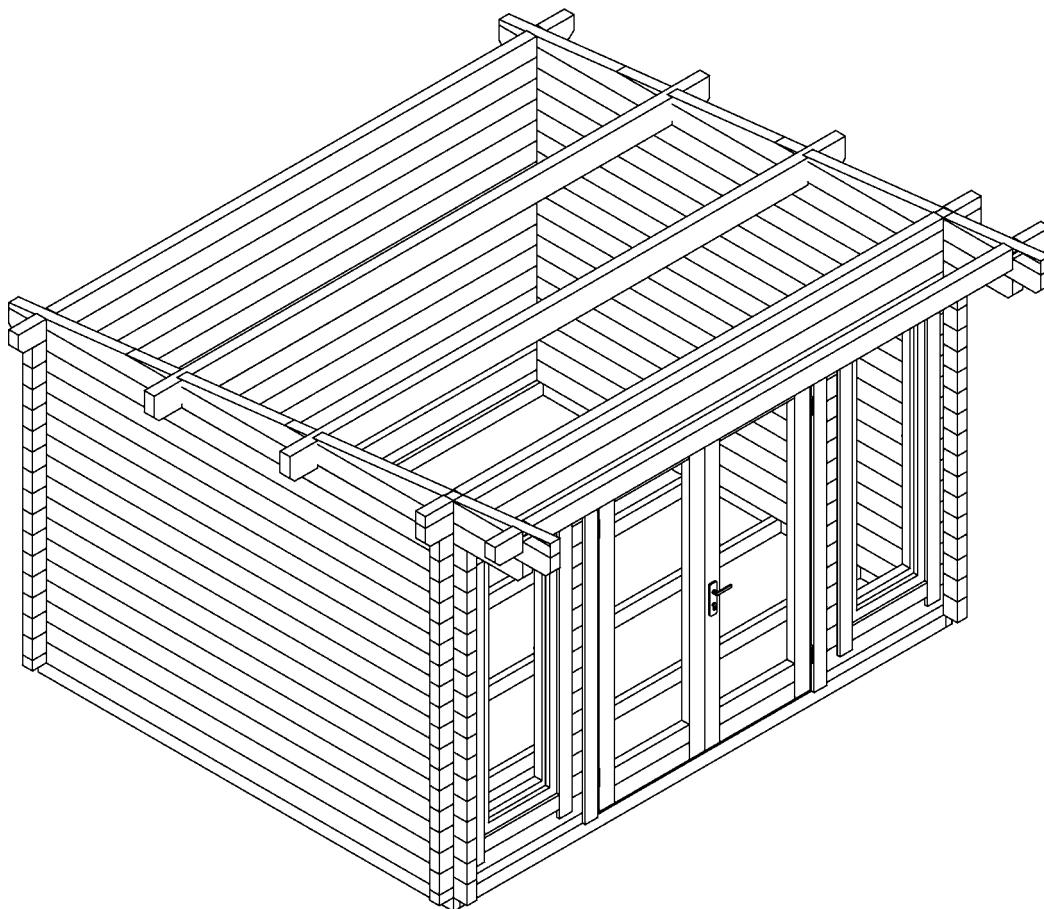





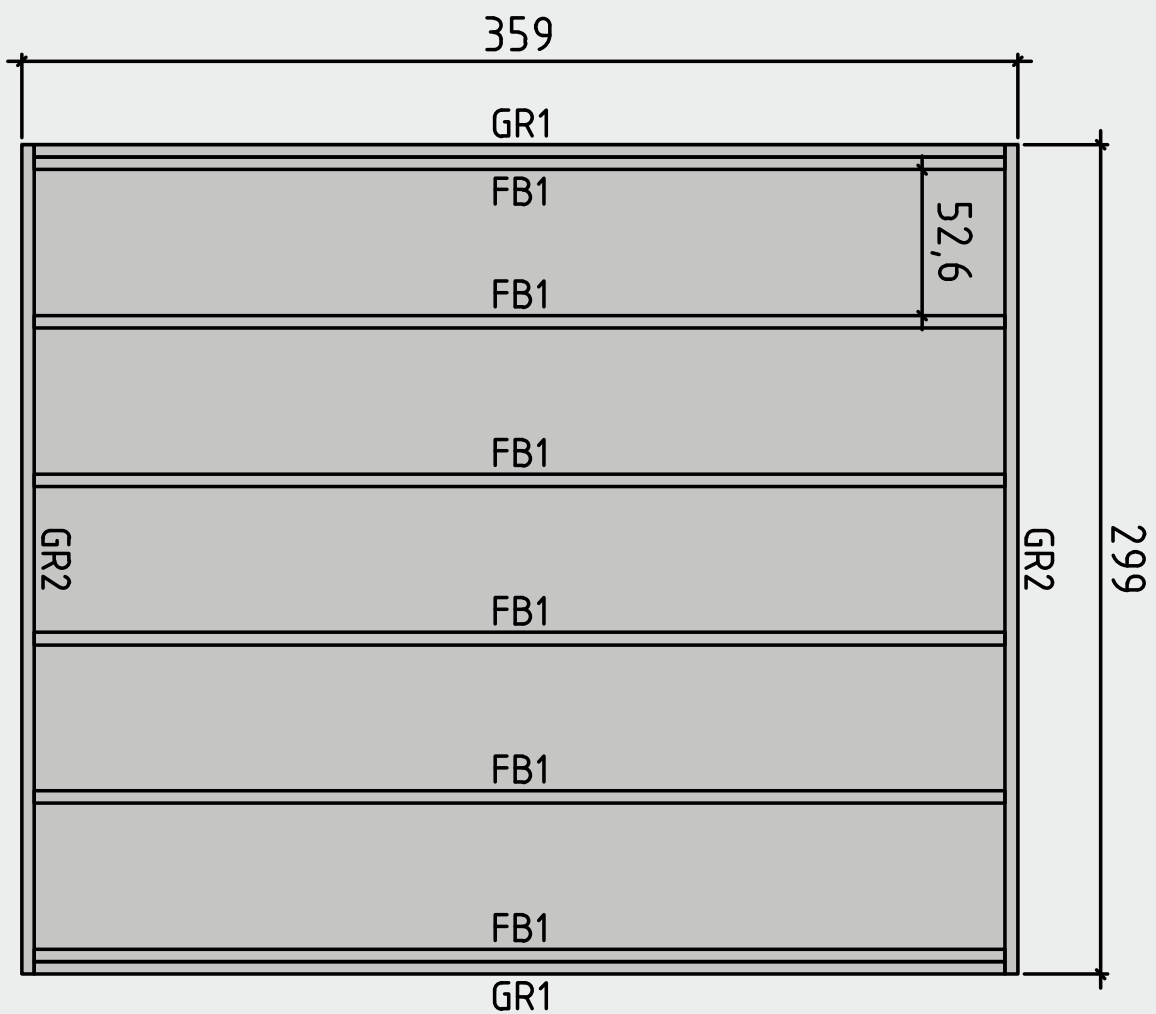

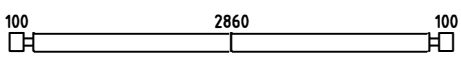
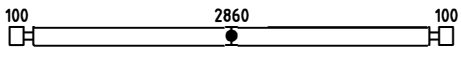
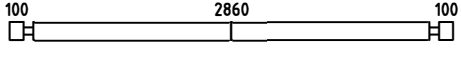
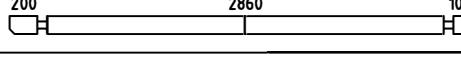
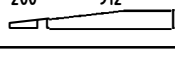
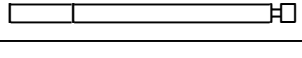

Lagerholzplan und Fundamentplan 870905

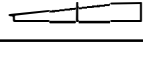
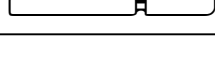
Wir empfehlen als Fundament für Ihr Gartenhaus eine vollflächig,
festgegründete gepflasterte oder betonierte Fläche.
Wahlweise ist auch ein Punkt- oder Streifenfundament möglich.

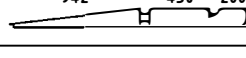

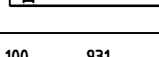
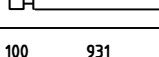
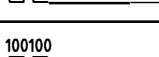

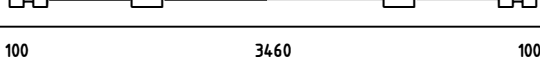
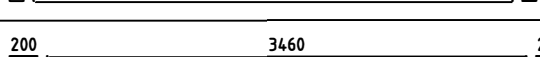
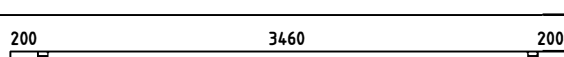
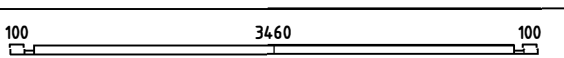
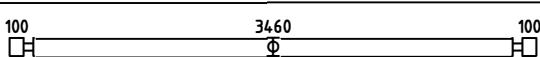
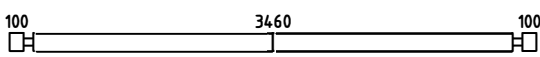
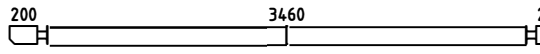
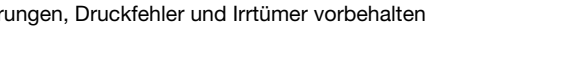





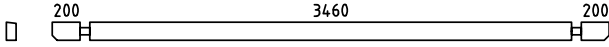
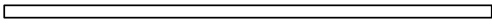
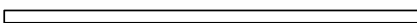
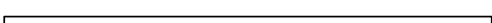
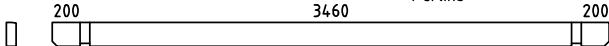

Teilleiste 1 870905

Pos			Profil (mm)	Lenght (mm)
001		2	70x130	3200
002		2	70x130	3200
003		26	70x130	3200
004		2	70x130	3300
005		2	70x130	1182
006		2	70x130	2058
007		2	70x39	340
008		2	70x130	947
009		2	70x130	1482
010		2	70x20	173
011		2	70x130	1712
012		2	70x88	772
013		2	70x65	1101
014		2	70x130	1101
015		2	70x130	1101
016		26	70x130	270
017		26	70x130	221
018		1	70x130	3800
019		1	70x130	3800
020		1	70x130	4000
021		1	70x73	4000
022		1	70x65	3800
023		1	70x130	3800
024		14	70x130	3800
025		1	70x130	4000

Teileliste 2

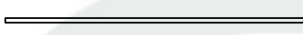
870905

Pos			Profil (mm)	Lenght (mm)
026			70x130	4000
		GROUNDFRAME		
GR1			45x90	3500
		GROUNDFRAME		
GR2			45x90	2990
		FLOORBEAMS		
FB1			45x90	3500
		Purlins		
PR1			70x170	4000
70mm A-5	WINDOW 600x1770			
VOLFF 70 M DOUBL DOOR 1H	DOOR 1588x2050			
1	Screws/Schrauben/Vis 5x100 mm- For fixing first row of wall logs /Fixierung des ersten Bohlenkranzes/Pour fixer les lamesde plancher			6
2	Nails/Nägel/Clous 2.5x50 - For fixing floorboards/ Befestigung Fussbodenbretter/Pour fixer les lames de plancher			250
3	Nails/Nägel/Clous 2.5x50 - For fixing roofboards/ Befestigung Dachbretter/Pour fixer les voliges			250
4	Nails/Nägel/Clous 2.5x50 - For fixing floor edge trims/ Befestigung Fussleisten/Pour fixer les plinthes du plancher			30
5	Nails/Nägel/Clous 2.5x50 - For fixing roofing felt fillet/ Befestigung giebelabschlussbrett/Pour fixer la latte de finition de la couverture			20
6	Screws/Schrauben/Vis 2,5x50 mm- For fixing roof side boards and roof edge reinforcement Befestigung Traufenbretter und Traufenteisten Pour fixer les planches de rive et le tasseau de refront			125
7	Screws/Schrauben/Vis 2,5x50 mm- For fixing fascia boards and diamonds/ Befestigung Giebelblende und Raute Pour fixer les planches de rive et le diamant			
8	Screws/Schrauben/Vis 2,5x50 mm- For fixing fwindow and door trims/ Befestigung Fenster und türen/ Pour fixer les croisillons des fenetres et des portes			
9	Metal storm Brace/Gewindestange/Tige filetee 10 mm			3
10	Shim/Nuts/Mutter ,U-Scheibe/Ecrou;Rondelle 10 mm For fixing storm braces/ Pour fixer les anti tempete/ Für Sturmleisten Pour fixer les croisillons des fenetres et des portes Metal storm Brace/Gewindestange/Tige filetee 10 mm KL1 M10 2,31 m 2 Screws 180 6 pcs. KL2 M10 2,11 m 1 Plastic caps 3 pcs.			3/3

Teileliste 3

870905

Specification for "Trondheim 70-A XL" 70x130 mm					
POS	ST.	B	H	L	Teileliste
FB1	Vt. spetsi				FUNDMENTHOLZER
F1	9,9m ²	28		2855	FUSSBODENBRETTER
PR	2	70	170	4000	DACHBALKEN
RB1	15,7m ²	20		3925	DACHBRETTER
R1	2	20	140	4040	<small>Vasta ketise kalveni rka</small> Traufenbretter
R2	2	45	65	4000	<small>Vasta ketise kalveni rka</small> Traufenbretter
R3	2	20	140	4120	<small>Vasta ketise kalveni rka</small> Giebelabschlussleiste
R4	2	20	90	4120	Giebelabschlussleiste
WN06	2	600	1770		<p style="text-align: center;">Sliding slats 30x30x1600 mm - 4 pcs.</p>
DR16	1	1588	2050		
P1	14m	20	40		Fußbodenleiste
P2	4+4	20	90	1920	Fensterleiste WN 06
P3	1+1	20	90	3440	Türleiste DR 16, Fensterleiste WN 06
P4	2+2	20	90	540 570	Fensterleiste WN 06
P5	2+2	20	90	2030	Türleiste DR 16

Detailzeichnungen 870905

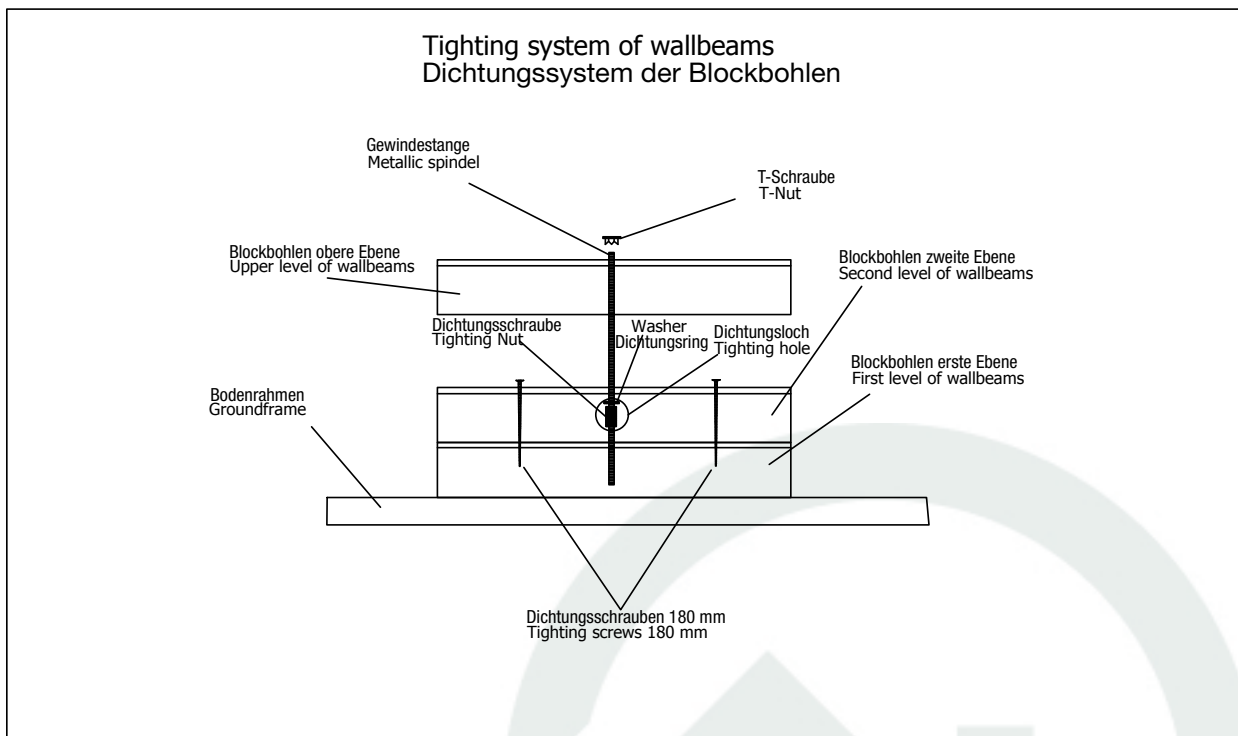
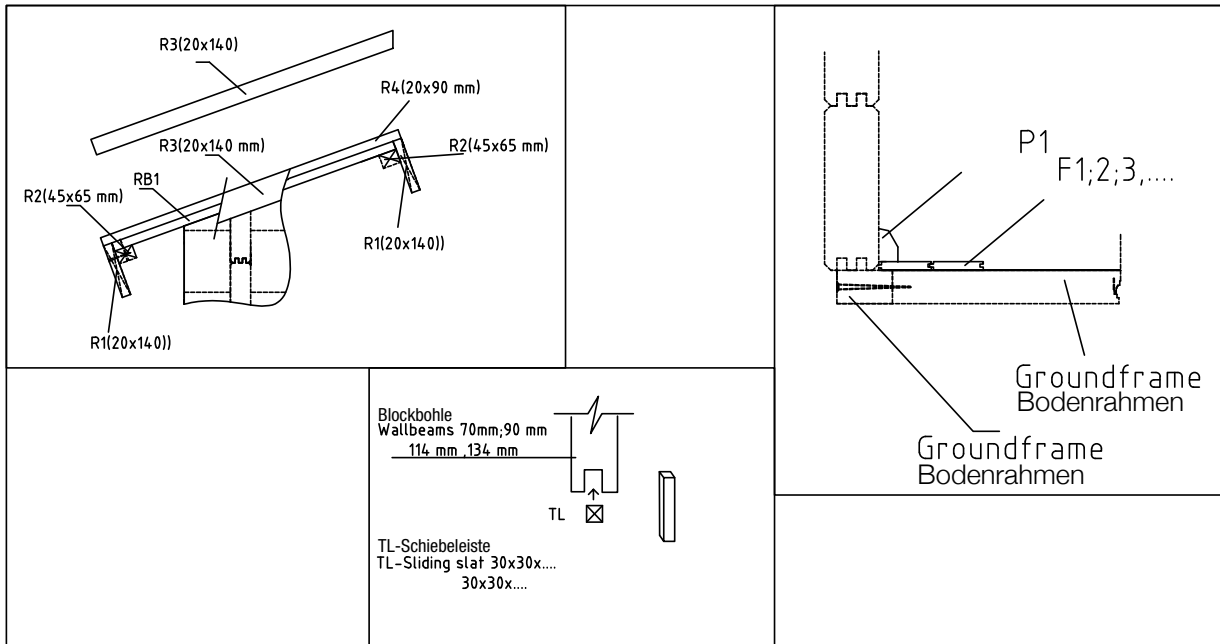

Wandplan 1 und 2 870905

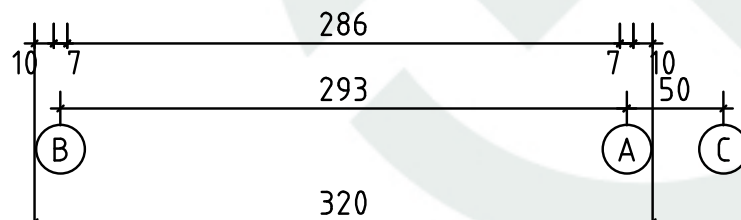
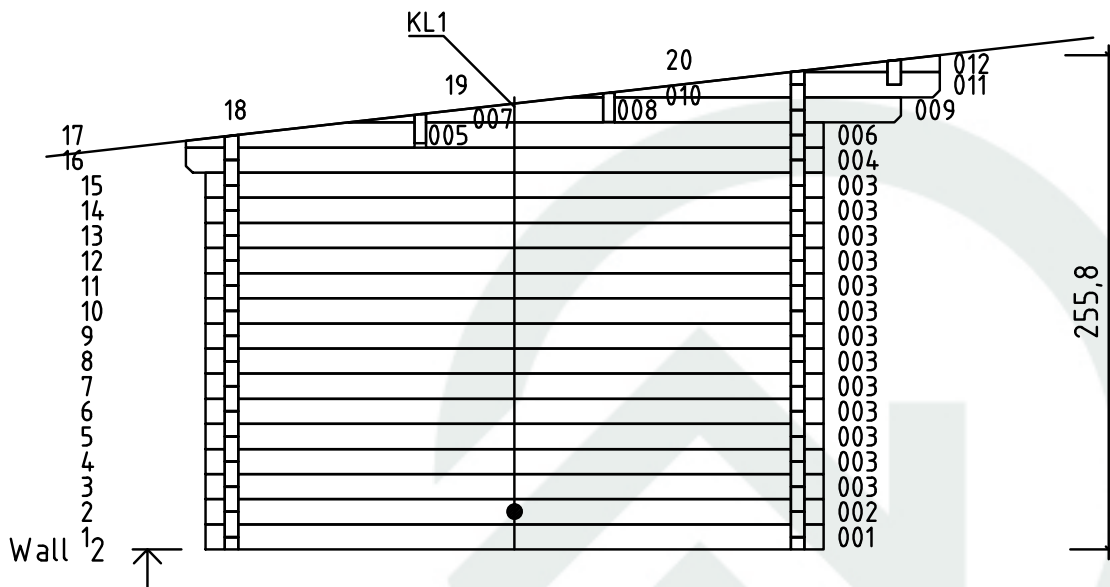
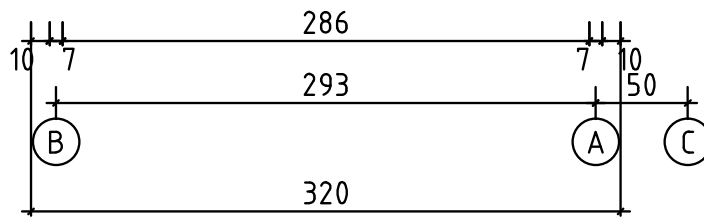
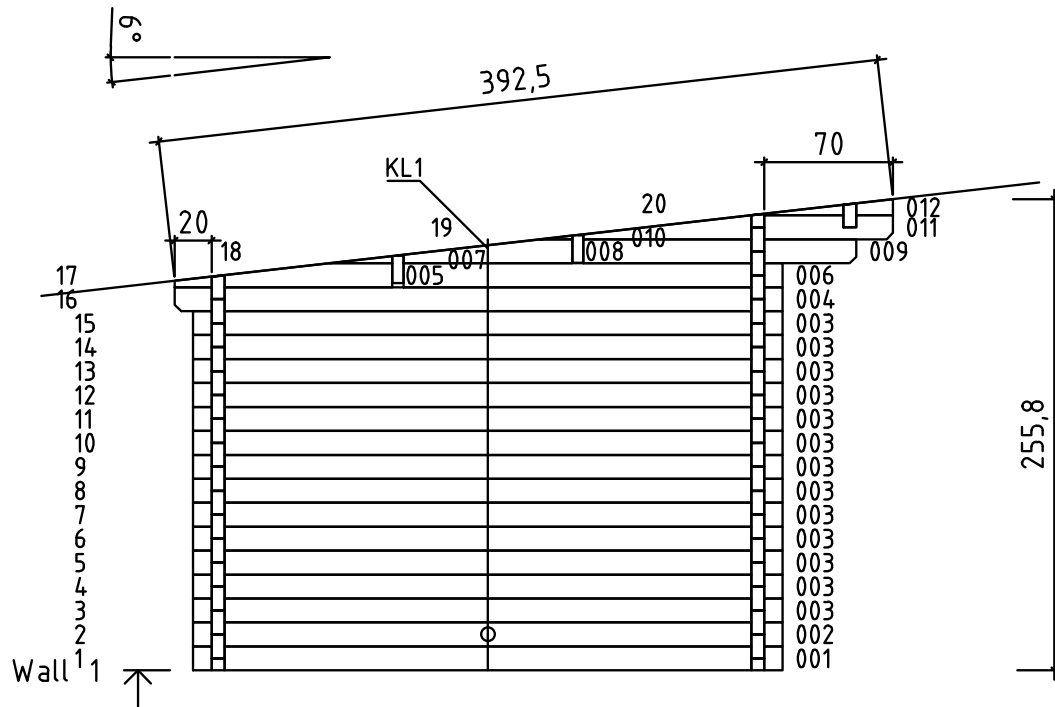

Wandplan A und B 870905

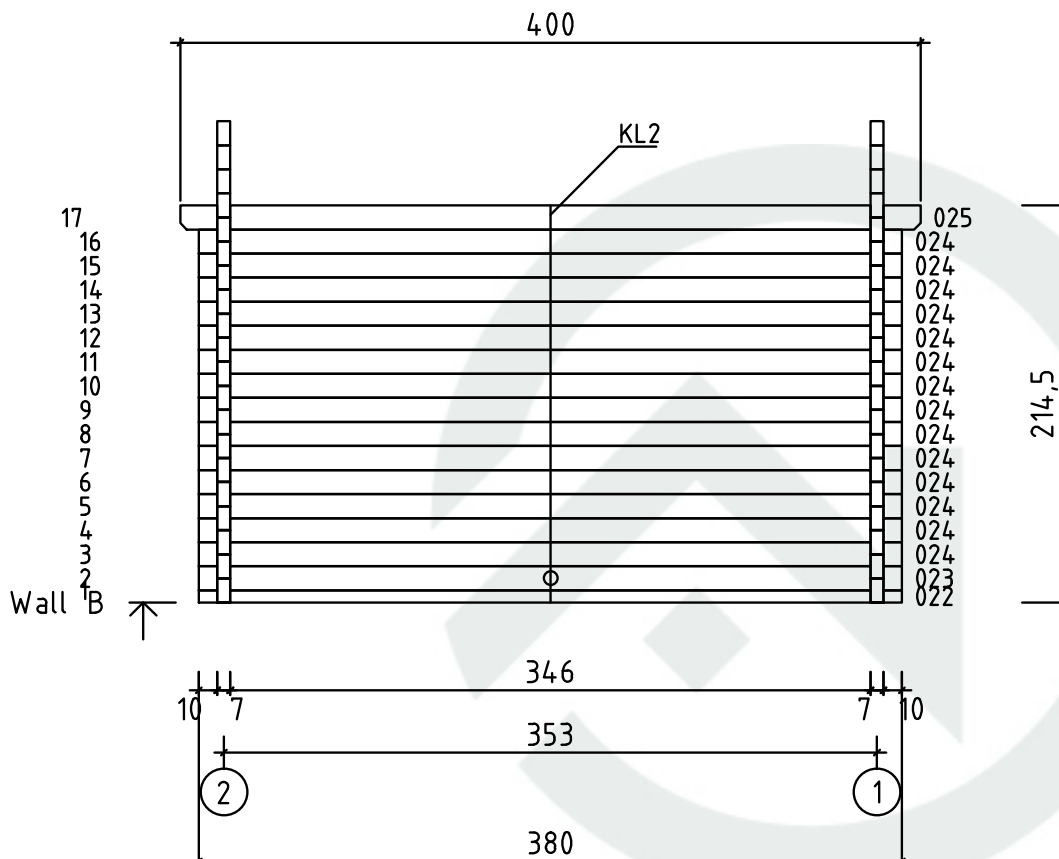
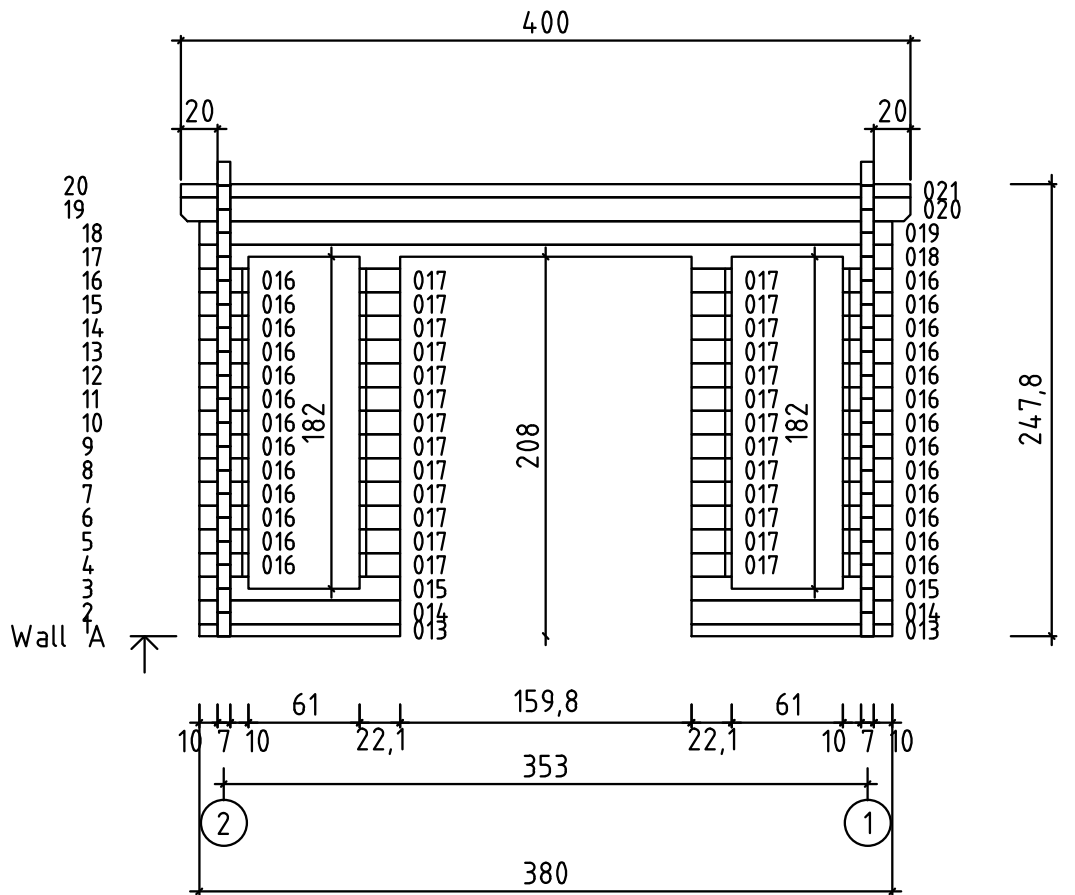

Wandplan C 870905

Vorgelagerte Vordachbohle vor Wand A

