

# Technische Daten: Art.-Nr.: 592140

Wandaußenmaß: 760 x 710 cm

Bohlenstärke: 92 mm



Kontrolliert durch:

Empty box for signature or name.

Achtung: Alle angegebenen Maße sind ca.-Maße!

# 3D-Darstellung 592140

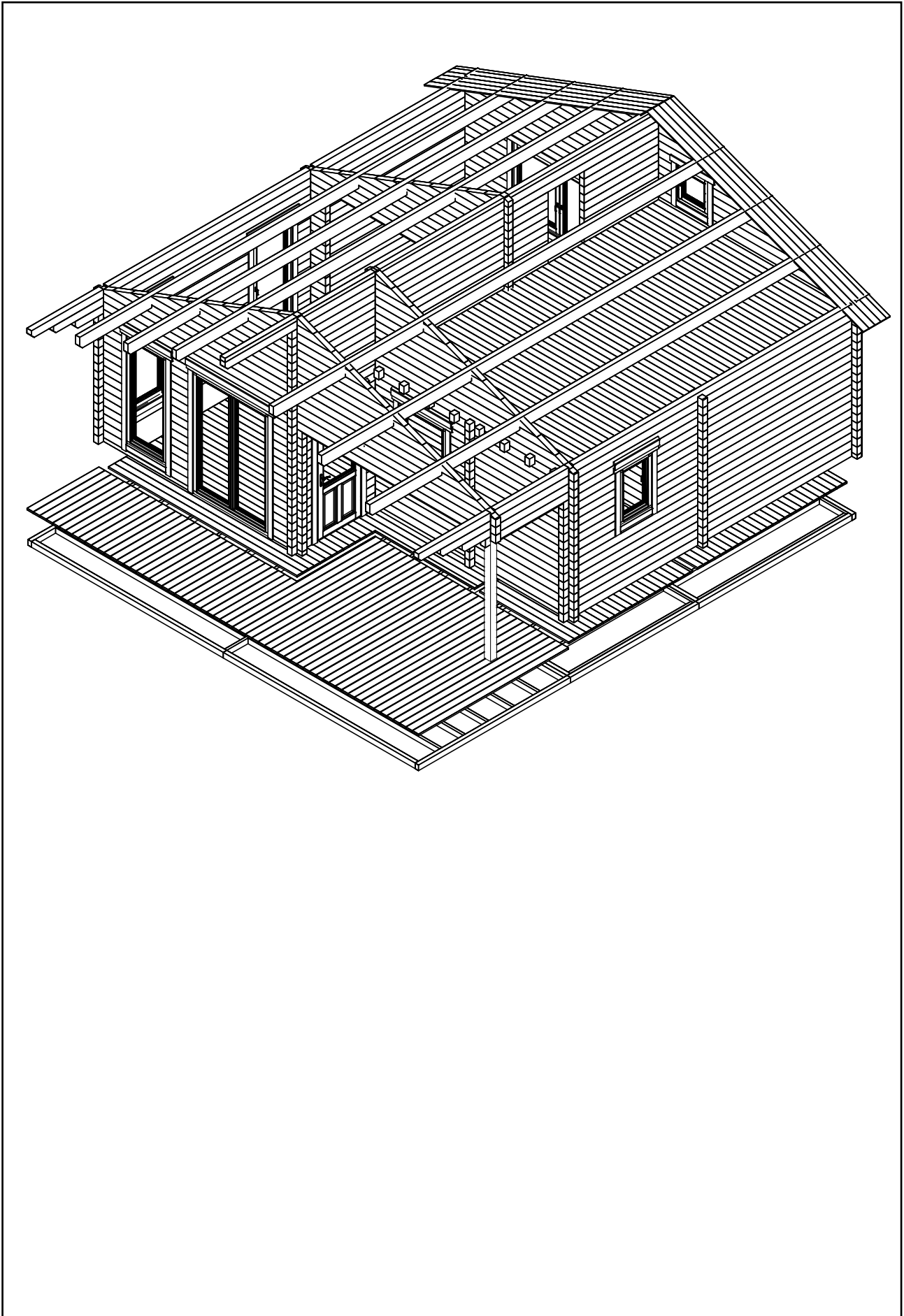

# 3D-Darstellung 592140

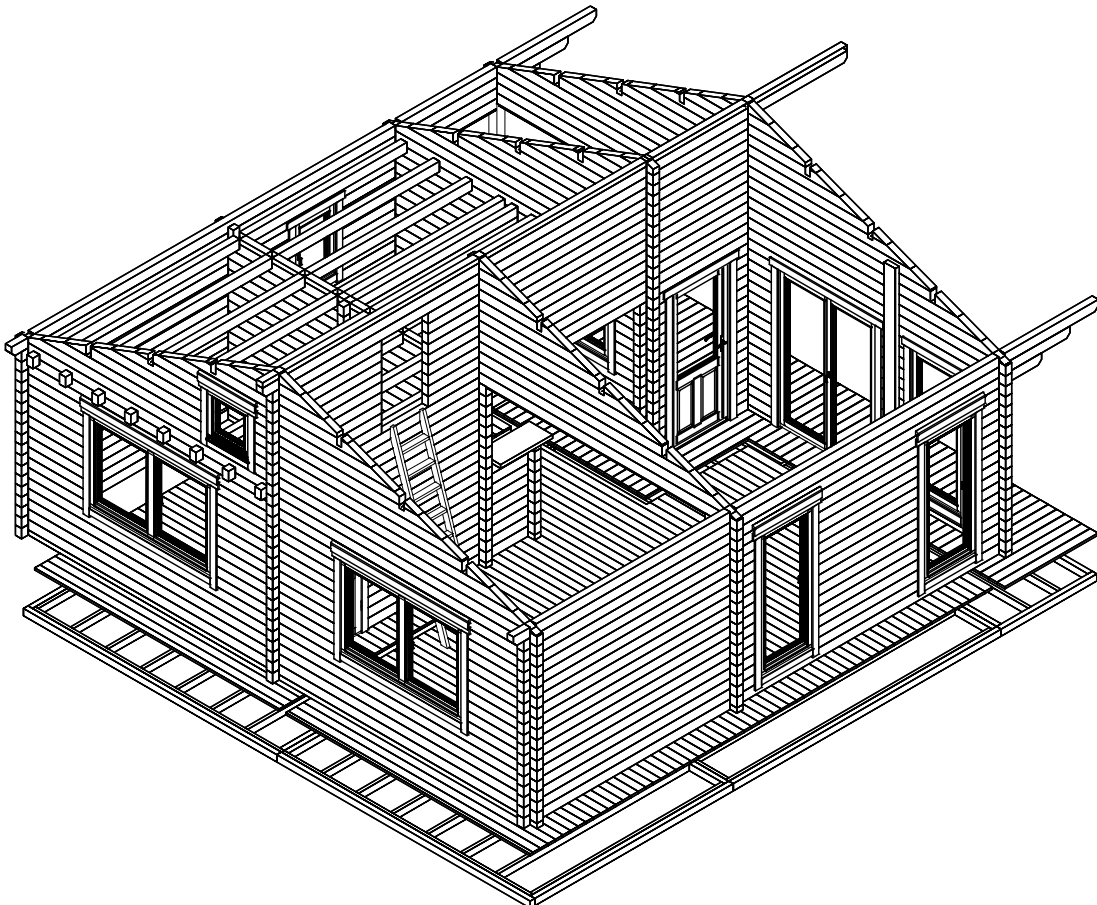
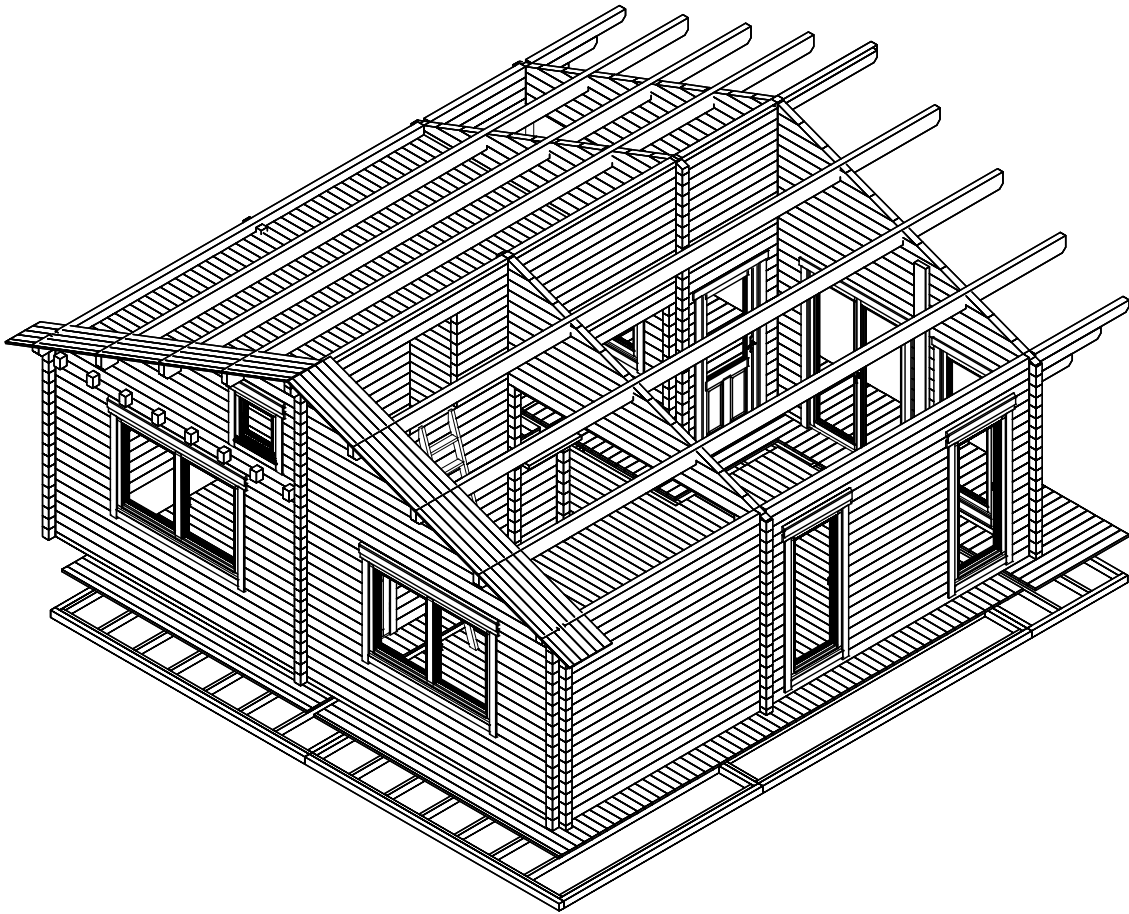

# Grundriss 592140

Die Fenster für Schlafboden

1xIV68-1  
65x65

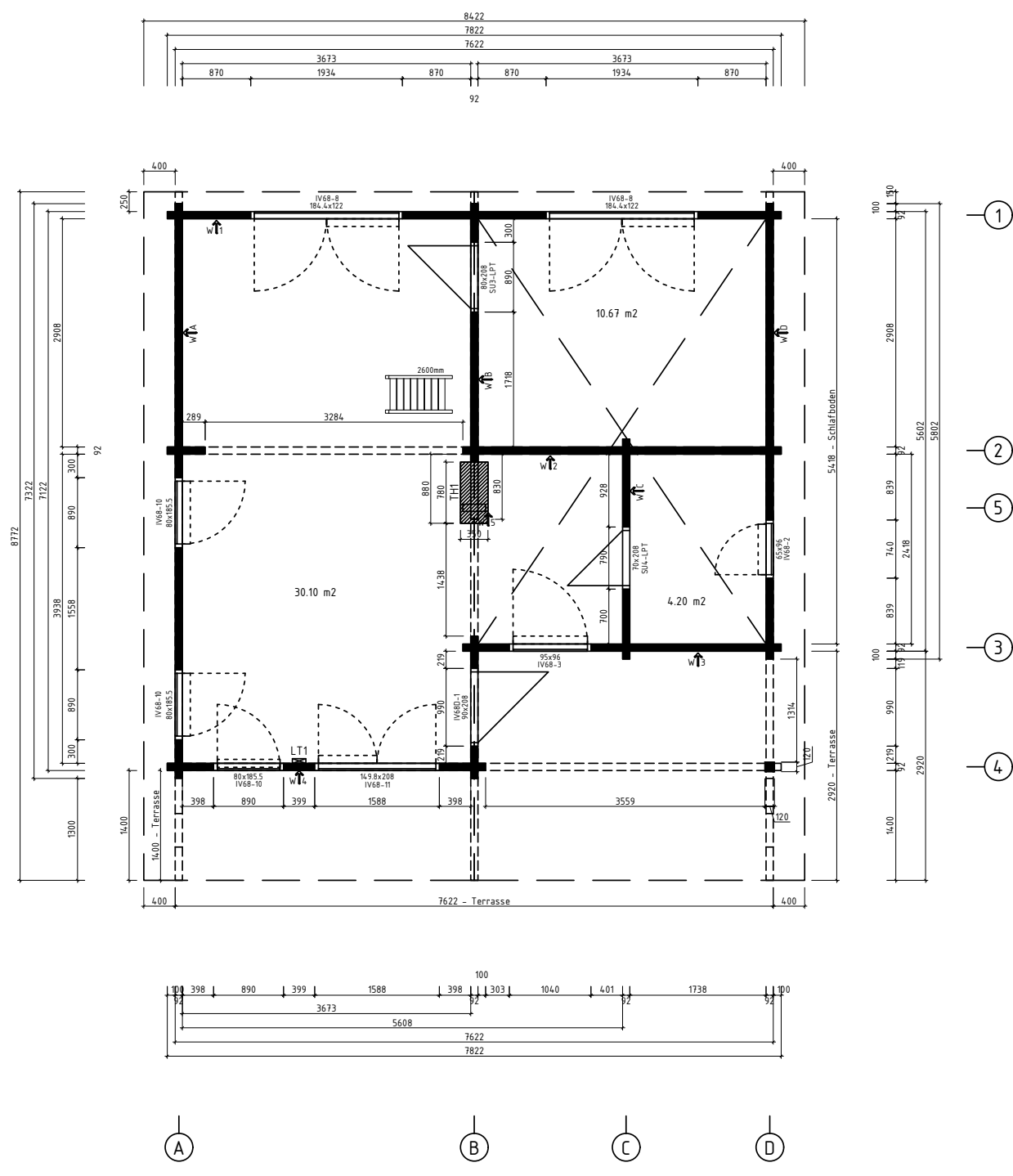

- Schlafboden/sleeping floor

\* Fenster und Türen sind ohne Sprossen

# Lagerholzplan und Fundamentplan 592140

**Wir empfehlen als Fundament für Ihr Gartenhaus eine vollflächig festgegründete, gepflasterte oder betonierte Fläche.  
Wahlweise ist auch ein Punkt- oder Streifenfundament möglich.**

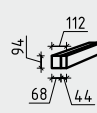
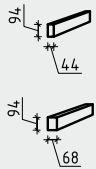
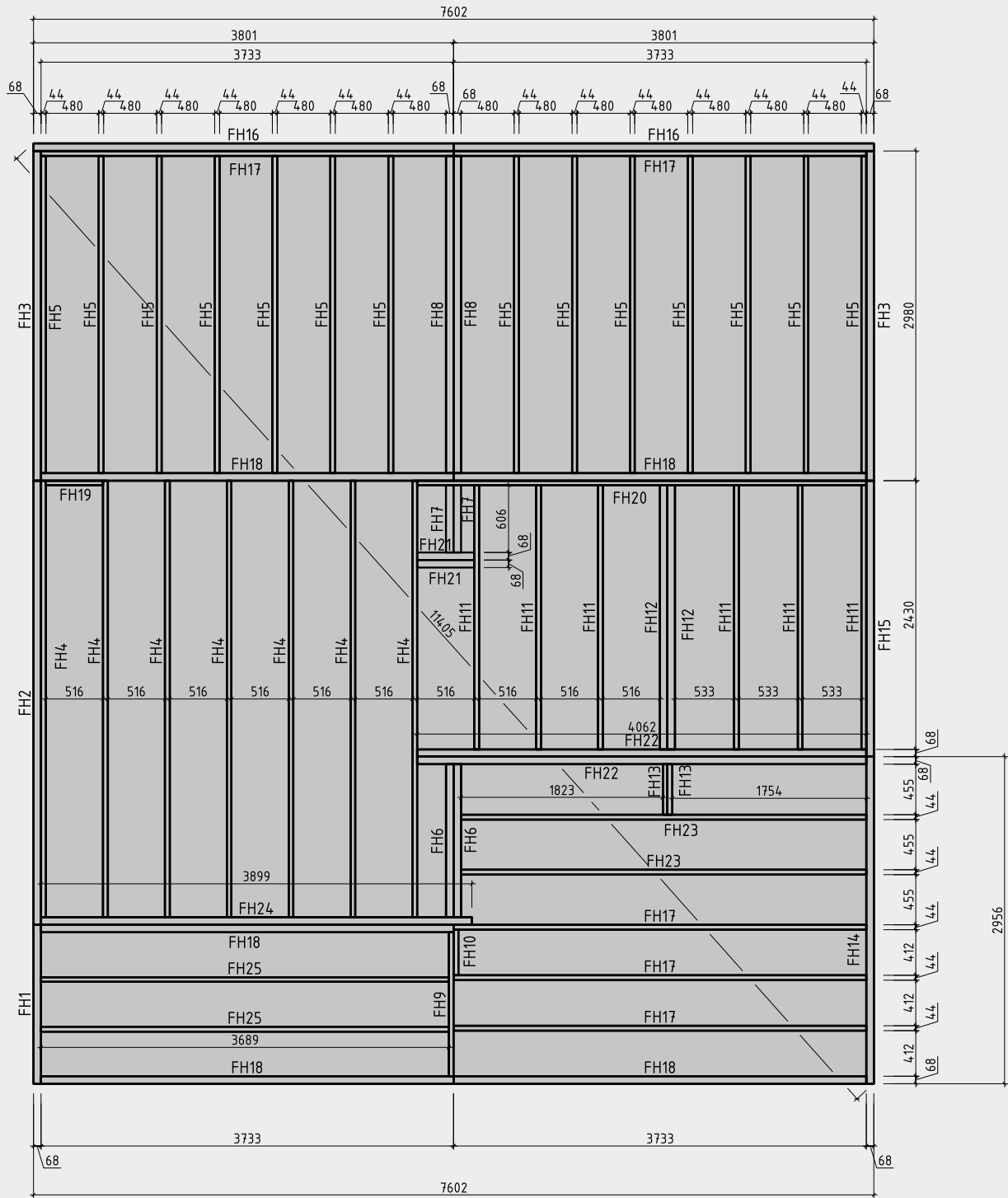

# Teileliste 1

## 592140

Pos		Stck	Profil (mm)	Länge (mm)
001		1	92x135	7822
002		3	92x135	7822
003		1	92x135	7822
004		1	92x135	7772
005		1	92x135	7772
006		1	92x135	7322
007		1	92x135	7322
008		1	92x135	7322
009		1	92x135	7084
010		1	92x67	5806
011		1	92x135	5806
012		8	92x135	5802
013		1	92x135	5656
014		1	92x135	5571
015		1	92x135	5476
016		1	92x135	5476
017		1	92x135	5051
018		1	92x135	5051
019		8	92x135	4987
020		1	92x135	4987
021		1	92x135	4959
022		1	92x135	4176
023		1	92x135	4176
024		1	92x135	4176
025		1	92x135	4057

# Teileliste 2

## 592140

Pos		Stck	Profil (mm)	Länge (mm)
026		1	92x135	4057
027		16	92x135	4057
028		1	92x68	4057
029		1	92x135	4057
030		8	92x135	4057
031		1	92x135	4057
032		1	92x68	4057
033		1	92x135	4042
034		1	92x135	4035
035		1	92x135	4031
036		6	92x135	4031
037		1	92x135	4020
038		1	92x135	3911
039		1	92x135	3911
040		1	92x135	3911
041		1	92x135	3911
042		2	92x135	3911
043		1	92x68	3911
044		1	92x135	3911
045		5	92x135	3911
046		1	92x135	3911
047		1	92x68	3911
048		1	92x135	3911
049		1	92x135	3896
050		2	92x135	3896

# Teileliste 3

## 592140

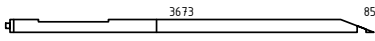
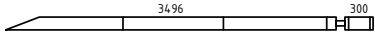
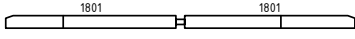
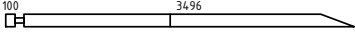
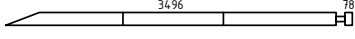
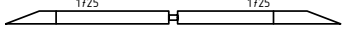
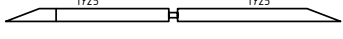
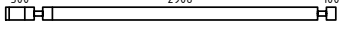
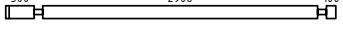
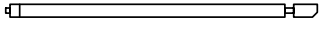
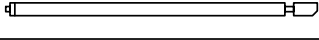
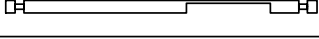
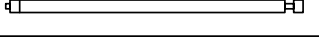
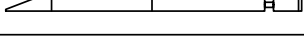
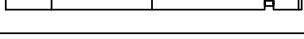
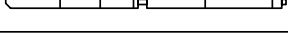
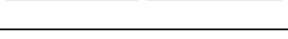
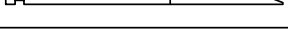
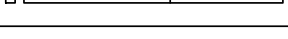
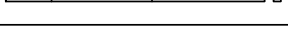
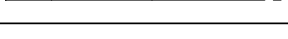
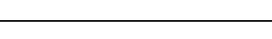
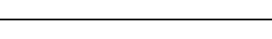
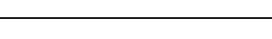
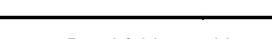
Pos		Stck	Profil (mm)	Länge (mm)
051		1	92x135	3896
052		1	92x135	3888
053		1	92x135	3695
054		1	92x135	3688
055		1	92x135	3666
056		1	92x135	3542
057		1	92x135	3542
058		2	92x135	3492
059		11	92x135	3492
060		1	92x135	3296
061		1	92x135	3296
062		1	92x135	3292
063		5	92x135	3146
064		1	92x135	3132
065		1	92x135	3132
066		1	92x135	2966
067		1	92x67	2966
068		1	92x135	2932
069		1	92x135	2932
070		1	92x135	2910
071		1	92x135	2909
072		1	92x135	2834
073		1	92x135	2834
074		1	92x135	2825
075		1	92x128	2802





# Teileliste 4

## 592140

Pos		Stck	Profil (mm)	Länge (mm)
076		1	92x135	2802
077		1	92x135	2802
078		1	92x135	2786
079		1	92x135	2786
080		1	92x135	2640
081		8	92x135	2640
082		1	92x135	2625
083		1	92x135	2603
084		1	92x135	2456
085		7	92x135	2423
086		1	92x135	2193
087		1	92x135	1993
088		1	92x135	1971
089		1	92x135	1917
090		6	92x135	1910
091		1	92x135	1895
092		1	92x68	1879
093		1	92x135	1879
094		1	92x135	1831
095		7	92x135	1831
096		1	92x135	1831
097		2	92x135	1818
098		1	92x135	1812
099		1	92x135	1700
100		1	92x135	1700



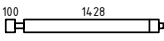
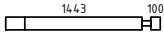
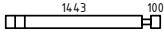
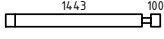
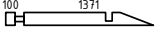
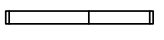
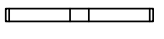
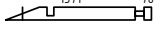
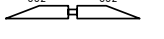
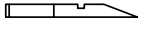
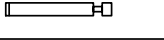
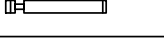
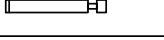
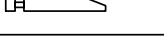
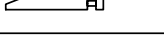
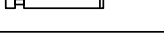
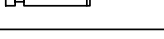
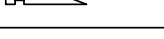
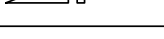
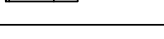
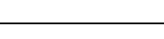
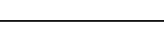
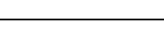
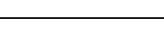





















# Teileliste 5

## 592140

Pos		Stck	Profil (mm)	Länge (mm)
101		1	92x135	1666
102		4	92x135	1635
103		2	92x135	1635
104		3	92x135	1635
105		1	92x135	1563
106		9	92x135	1558
107		4	92x135	1558
108		1	92x135	1541
109		2	92x135	1417
110		1	92x135	1393
111		15	92x135	1120
112		9	92x135	1062
113		9	92x135	1062
114		1	92x135	1055
115		1	92x135	1033
116		7	92x135	1031
117		15	92x135	892
118		1	92x135	854
119		1	92x135	832
120		1	92x135	761
121		2	92x117	708
122		7	92x135	594
123		14	92x135	590
124		1	92x68	590
125		15	92x135	590

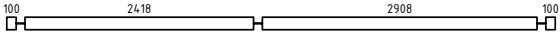









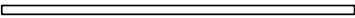

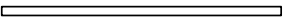











# Teileliste 6

## 592140

Pos		Stck	Profil (mm)	Länge (mm)
126		1	92x117	500
127		28	92x135	492
128		9	92x135	481
129		4	92x135	481
130		4	92x135	481
131		1	92x68	481
132		1	92x117	478
133		30	92x135	411
134		10	92x135	399
135		4	92x135	399
136		6	92x68	397
137		1	92x68	397
138		6	92x126	332
139		1	92x68	292
140		8	92x135	292
141		1	92x68	292
142		1	92x135	270
143		6	92x79	207
144		4	92x32	83
145		2	92x32	83
ÜT1		8	92x135	5802
FH22		2	68x94	4062
FH2		1	68x94	4018
FH24		1	68x94	3899
FH16		2	68x94	3801











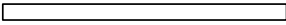
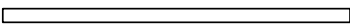
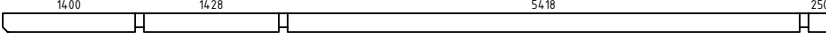
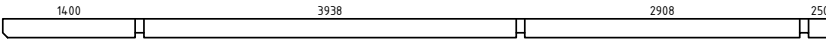
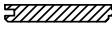
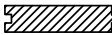









# Teileliste 7

## 592140

Pos		Stck	Profil (mm)	Länge (mm)
FH18	FUNDAMENTHÖLZER (imprägniert) 	5	68x94	3733
FH3	FUNDAMENTHÖLZER (imprägniert) 	2	68x94	2980
FH14	FUNDAMENTHÖLZER (imprägniert) 	1	68x94	2956
FH8	FUNDAMENTHÖLZER (imprägniert) 	2	68x94	2868
FH15	FUNDAMENTHÖLZER (imprägniert) 	1	68x94	2498
FH12	FUNDAMENTHÖLZER (imprägniert) 	2	68x94	2386
FH1	FUNDAMENTHÖLZER (imprägniert) 	1	68x94	1436
FH6	FUNDAMENTHÖLZER (imprägniert) 	2	68x94	1384
FH7	FUNDAMENTHÖLZER (imprägniert) 	2	68x94	606
FH21	FUNDAMENTHÖLZER (imprägniert) 	2	68x94	516
FH20	FUNDAMENTHÖLZER (imprägniert) 	1	44x94	4062
FH4	FUNDAMENTHÖLZER (imprägniert) 	7	44x94	3950
FH17	FUNDAMENTHÖLZER (imprägniert) 	5	44x94	3733
FH25	FUNDAMENTHÖLZER (imprägniert) 	2	44x94	3689
FH23	FUNDAMENTHÖLZER (imprägniert) 	2	44x94	3665
FH5	FUNDAMENTHÖLZER (imprägniert) 	14	44x94	2868
FH11	FUNDAMENTHÖLZER (imprägniert) 	6	44x94	2386
FH9	FUNDAMENTHÖLZER (imprägniert) 	1	44x94	1300
FH19	FUNDAMENTHÖLZER (imprägniert) 	1	44x94	516
FH13	FUNDAMENTHÖLZER (imprägniert) 	2	44x94	455
FH10	FUNDAMENTHÖLZER (imprägniert) 	1	44x94	412
LE3	LEISTE 	1	90x18	3573
LE2	LEISTE 	1	90x18	3284
LE1	LEISTE 	1	90x18	1314
TH1	THEKE 	1	350x50	780















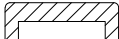
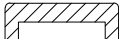



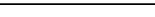
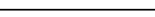
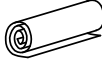

# Teileliste 8

## 592140

Pos		Stck	Profil (mm)	Länge (mm)
LT1	LATTEN (Stütze - Verstärkung Wand 4) 	✓ 1	58x170	3000
DLZ1	WASSERSCHUTZBRETT 	1	18x145	3670
PF2	PFETTEN 	3	80x200	8772
PF1	PFETTEN 	3	80x200	8772
	DACHBRETTER 	156+2	113x18	4505
	FUSSBODENBRETTER 	22+1	113x28	5600
	FUSSBODENBRETTER 	66	113x28	3665
	FUSSBODENBRETTER 	22	113x28	1730
	SCHLAFBODENBRETTER 	48+1	113x18	3665
	TERRASSENBRETTER (imprägniert) 	31+1	120x28	2915
	TERRASSENBRETTER (imprägniert) 	30	120x28	1395
	ABDECKLEISTEN für Decke (innen) 	✓	15x28	110,0 lfdm
	FUSSBODENLEISTEN 	✓	14x55	50,0 lfdm
	FUSSBODENLEISTE für Schlafboden 	✓	18x40	19,0 lfdm
G02-1	GIEBELBRETTER 18x120  20,9° ✓	4	18x120	4585
G01-1	GIEBELBRETTER 18x90  20,9° ✓	4	18x90	4585
G06-1	GIEBELDECKLEISTEN 18x58  20,9° ✓	4	18x58	4585
G08-1	GIEBELLEISTEN 18x58  20,9° ✓	4	18x58	4585
GS	Giebelsegment 	2		
T01-1	TRAUFENBRETTER 18x90 	4	18x90	4386
T06-1	TRAUFENLEISTEN 18x40 	✓	18x40	18,0 lfdm
TP1 20-1	STÜTZPFOSTEN 120x120 	✓ 1	120x120	1975
TL92-1	T-LEISTE 92 	2	45x92	625
TL9 2-2	T-LEISTE 92 	4	45x92	895
TL9 2-3	T-LEISTE 92 	4	45x92	1165



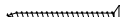













# Teileliste 9

## 592140

Pos			Stck	Profil (mm)	Länge (mm)
TL9 2-4	T-LEISTE 92		4	45x92	1705
TL9 2-5	T-LEISTE 92		2	45x92	1840
TL9 2-6	T-LEISTE 92		6	45x92	1975
TL9 2-7	T-LEISTE 92		2	45x92	2045
UP7-1	U-PROFIL 92	 ✓	2	40x120	760
UP7-2	U-PROFIL 92	 ✓	2	40x120	1275
SH	Schlaghölzer		3		
ML1	Metallstange		2	D18	1040
ML2	Metallstange		2	D18	970
ML3	Metallstange		7	D18	900
ML4	Metallstange		1	D18	830
ML5	Metallstange		8	D18	770
ML6	Metallstange		7	D18	630
ML7	Metallstange		6	D18	360
ML8	Metallstange		4	D18	290
KP-1	DACHPAPPE	 ✓		8,8m-10st.	94,0 lfdm
NG01	DACHPAPPNÄGEL 2.8x15		1600		
NG04	NÄGEL 2.5x50	Dachbretter Schlafbodenbretter 	2328		
NG05	NÄGEL 2.5x60	Terrassenbretter Fussbodenbretter 	2379		
SR32	SCHRAUBEN 3.0x30	Abdeckleisten 28x15 FBleisten Traufenleiste 40x18 	394		
SR37	SCHRAUBEN 3.5x45	Giebelleisten, Giebelbretter Traufenbretter, Giebelsegment U-Profil, LE1, LE2, LE3 Verbindungsstreifen Tür- und Fensterleisten 	626		
SR44	SCHRAUBEN 4.0x60	Wasserleiste WL1 Wasserschutzblech DLZ1 	39		
SR55	SCHRAUBEN 5.0x70	Stützpfeiler 	8		

# Teileliste 10

## 592140

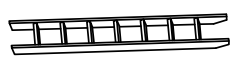
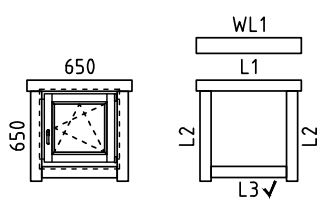
Pos		Stck	Profil (mm)	Länge (mm)																
SR57	SCHRAUBEN 5.0x100 Fundamenthölzer Theke TH1		276																	
VS	VERBINDUNGSSTREIFEN für verbinden der Wandbohlen		21																	
VP3	Verstellbare Pfostenstütze M20		1																	
KL1	Gewindestange M12		3	2000																
KL2	Gewindestange M12		1	1485																
KL3	Gewindestange M12		1	1215																
KL4	Gewindestange M12		1	945																
KL5	Gewindestange M12		1	810																
KL6	Gewindestange M12		3	663																
KL7	Gewindestange M12		2	540																
KL8	Gewindestange M12		2	405																
KL9	Gewindestange M12		2	270																
	Mutter M12		4																	
	Mutter M12 U-Scheibe Ø40		22																	
	U-Scheibe M12 Ø40		4																	
	Befestigungsmutter M12		3																	
DBA ND-1	DICHTUNGSBAND (letzte Bohlenkranz Seitenwänder)			18,0 lfdm																
TR02-1	LEITER 2600mm		1	2600																
	<p>FENSTER 650x650</p>  <p>IV68-1</p> <table border="0"> <tr> <td>L1</td> <td>18x90</td> <td>L=860mm</td> <td>2x</td> </tr> <tr> <td>L2</td> <td>18x90</td> <td>L=740mm</td> <td>4x</td> </tr> <tr> <td>L3</td> <td>18x90</td> <td>L=620mm</td> <td>2x✓</td> </tr> <tr> <td>WL1</td> <td>36x129</td> <td>L=860mm</td> <td>1x</td> </tr> </table>	L1	18x90	L=860mm	2x	L2	18x90	L=740mm	4x	L3	18x90	L=620mm	2x✓	WL1	36x129	L=860mm	1x	1	IV68-1	
L1	18x90	L=860mm	2x																	
L2	18x90	L=740mm	4x																	
L3	18x90	L=620mm	2x✓																	
WL1	36x129	L=860mm	1x																	

# Teileliste 11

## 592140

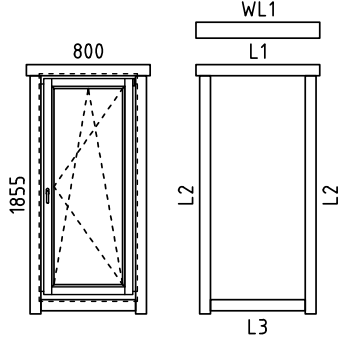
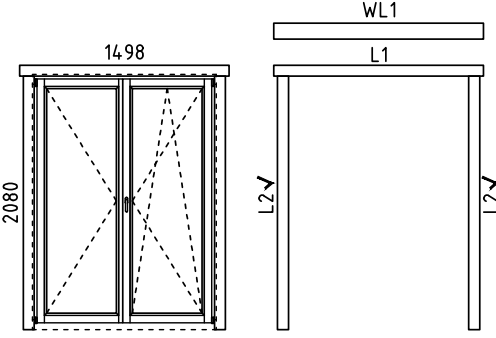
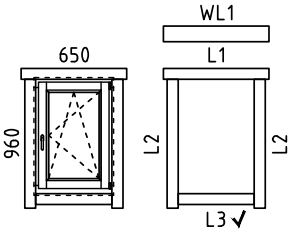
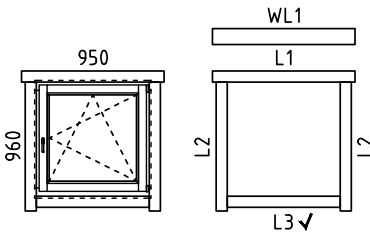
Pos		Stck	Profil (mm)	Länge (mm)
	<p style="text-align: center;">FENSTER 800x1855</p>  <p style="text-align: center;">IV68-10</p> <p>L1 18x90 L=1010mm 2x  L2 18x90 L=1940mm 4x  L3 18x90 L=770mm 2x ✓  WL1 36x129 L=1010mm 1x</p>	3	IV68-10	
	<p style="text-align: center;">FENSTER 1498x2080</p>  <p style="text-align: center;">IV68-11</p> <p>L1 18x90 L=1710mm 2x  L2 18x90 L=2070mm 4x ✓  WL1 36x129 L=1710mm 1x</p>	1	IV68-11	
	<p style="text-align: center;">FENSTER 650x960</p>  <p style="text-align: center;">IV68-2</p> <p>L1 18x90 L=860mm 2x  L2 18x90 L=1050mm 4x  L3 18x90 L=620mm 2x ✓  WL1 36x129 L=860mm 1x</p>	1	IV68-2	
	<p style="text-align: center;">FENSTER 950x960</p>  <p style="text-align: center;">IV68-3</p> <p>L1 18x90 L=1160mm 2x  L2 18x90 L=1050mm 4x  L3 18x90 L=920mm 2x ✓  WL1 36x129 L=1160mm 1x</p>	1	IV68-3	



# Teileliste 12

## 592140

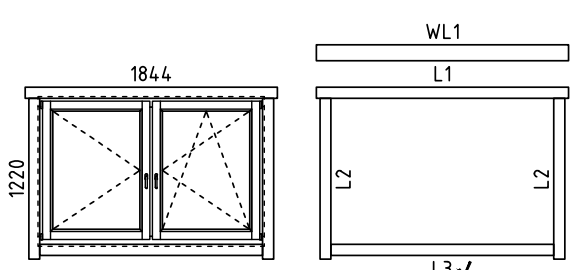
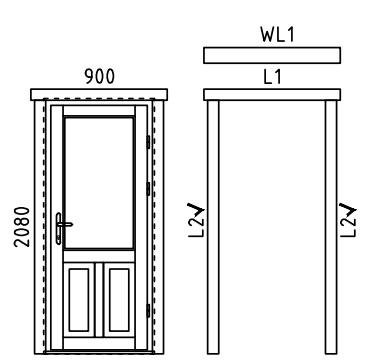
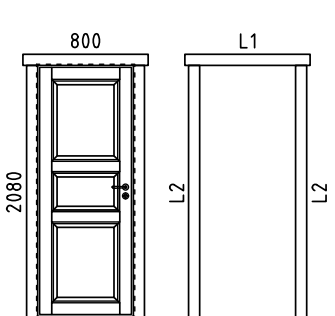
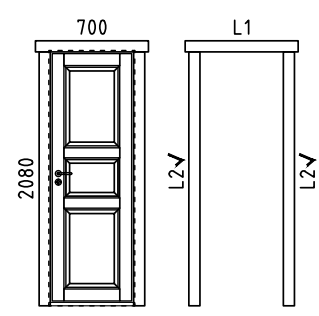
Pos		Stck	Profil (mm)	Länge (mm)
	<p>FENSTER 1844x1220</p>  <p>WL1 L1 L2 L3 ✓</p> <p>IV68-8</p> <p>L1 18x90 L=2055mm 2x L2 18x90 L=1310mm 4x L3 18x90 L=1815mm 2x ✓ WL1 36x129 L=2055mm 1x</p>	2	IV68-8	
	<p>TÜR 900x2080</p>  <p>WL1 L1 L2 ✓</p> <p>IV68D-1 (208)</p> <p>L1 18x90 L=1110mm 2x L2 18x90 L=2065mm 4x ✓ WL1 36x129 L=1110mm 1x</p> <p>DIN rechts</p>	1	IV68D-1	
	<p>TÜR 800x2080</p>  <p>L1 L2</p> <p>SU3_LPT</p> <p>L1 18x90 L=1020mm 2x L2 18x90 L=2070mm 4x ✓</p> <p>DIN links</p>	1	SU3-LPT	
	<p>TÜR 700x2080</p>  <p>L1 L2 ✓</p> <p>SU4_LPT</p> <p>L1 18x90 L=920mm 2x L2 18x90 L=2070mm 4x ✓</p> <p>DIN rechts</p>	1	SU4-LPT	
	<p>✓ - bitte selber anpassen (falls nötig)!</p>			

# Wandplan 1 592140

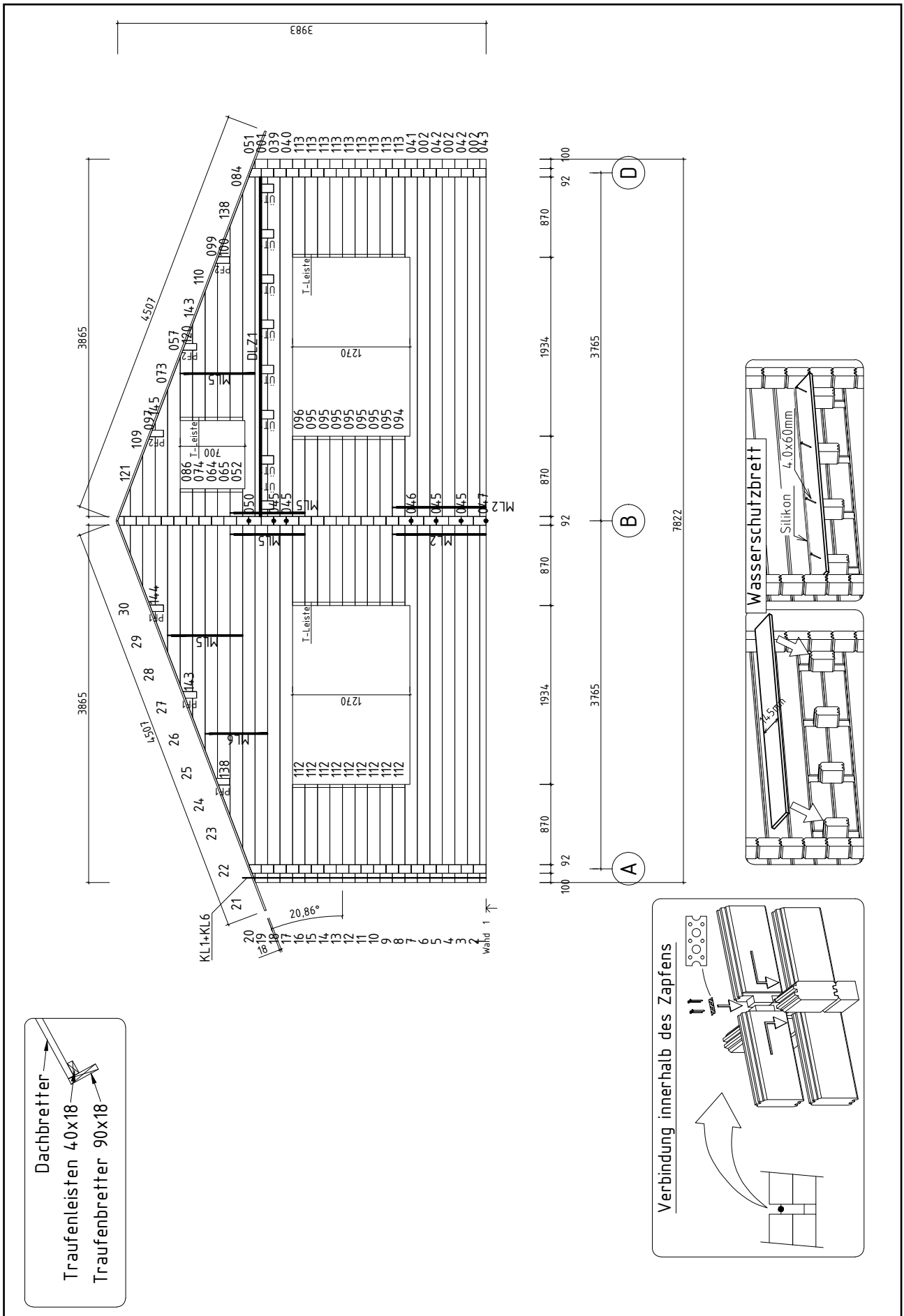

# Wandplan 2

## 592140

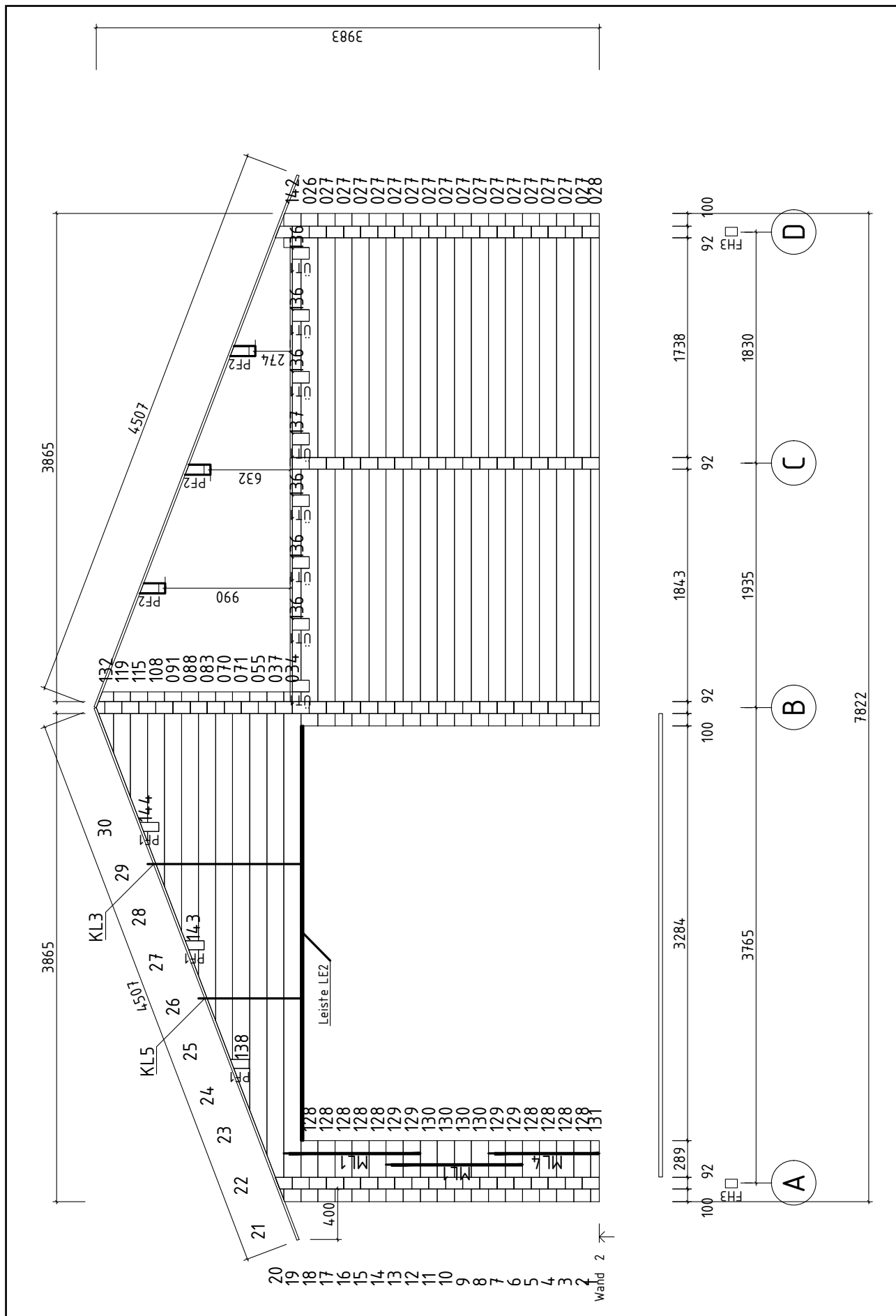

# Wandplan 3 592140

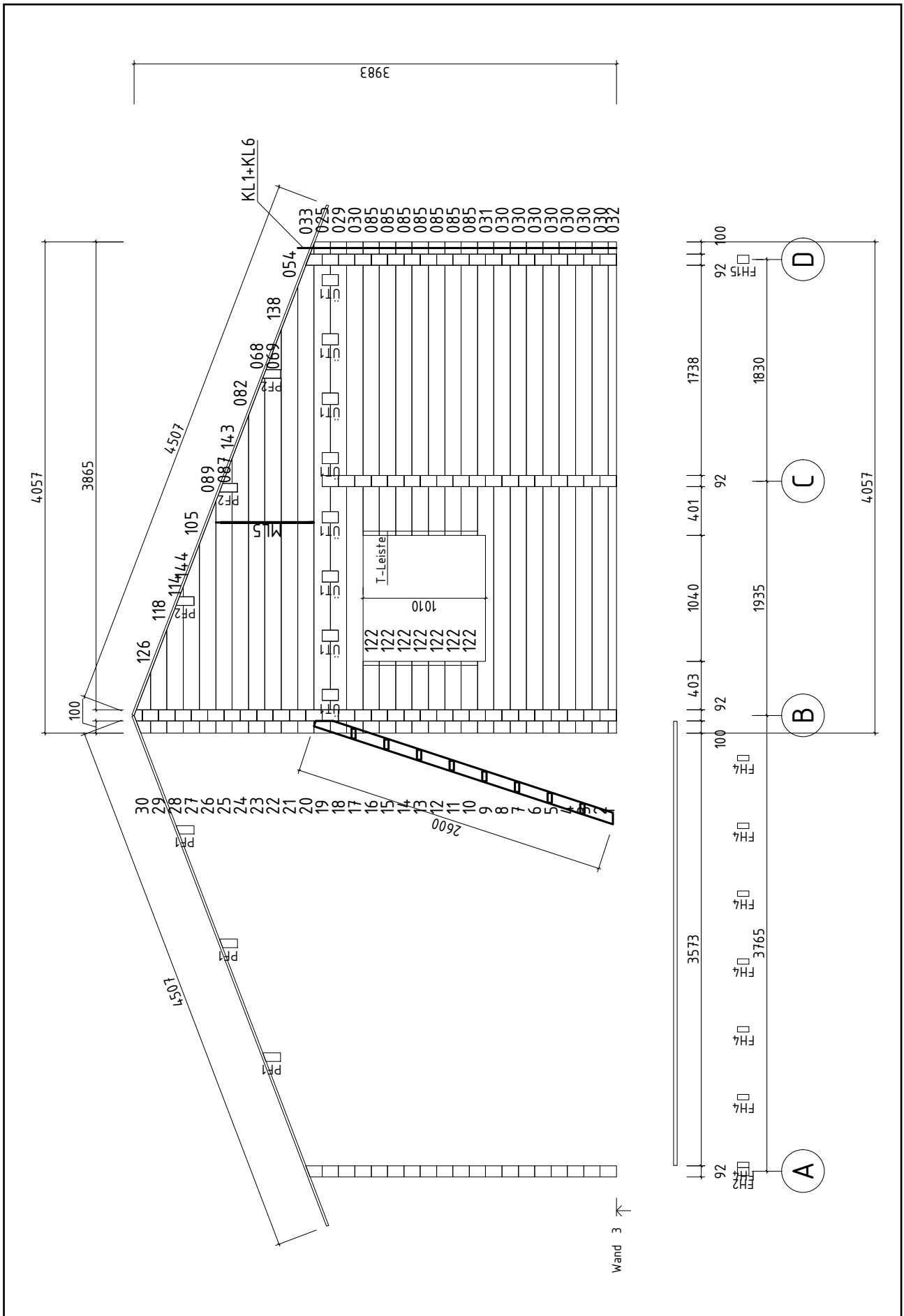

# Wandplan 4 592140

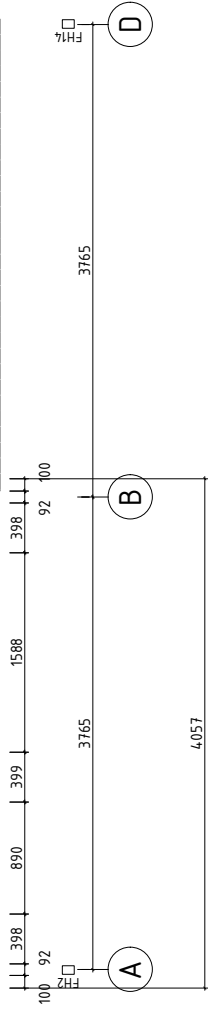
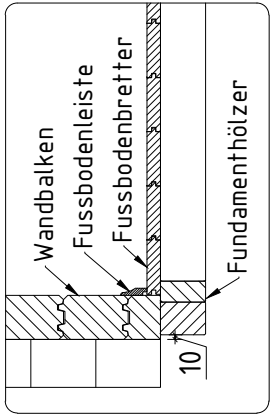
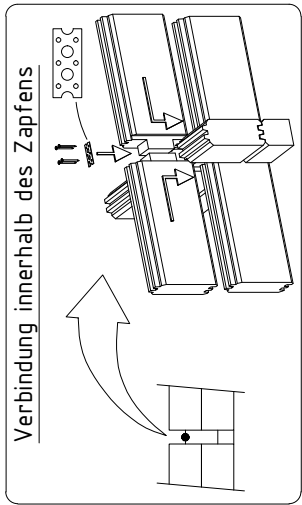
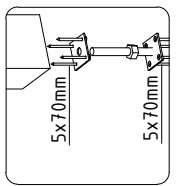
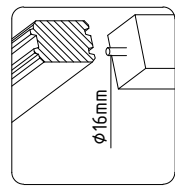
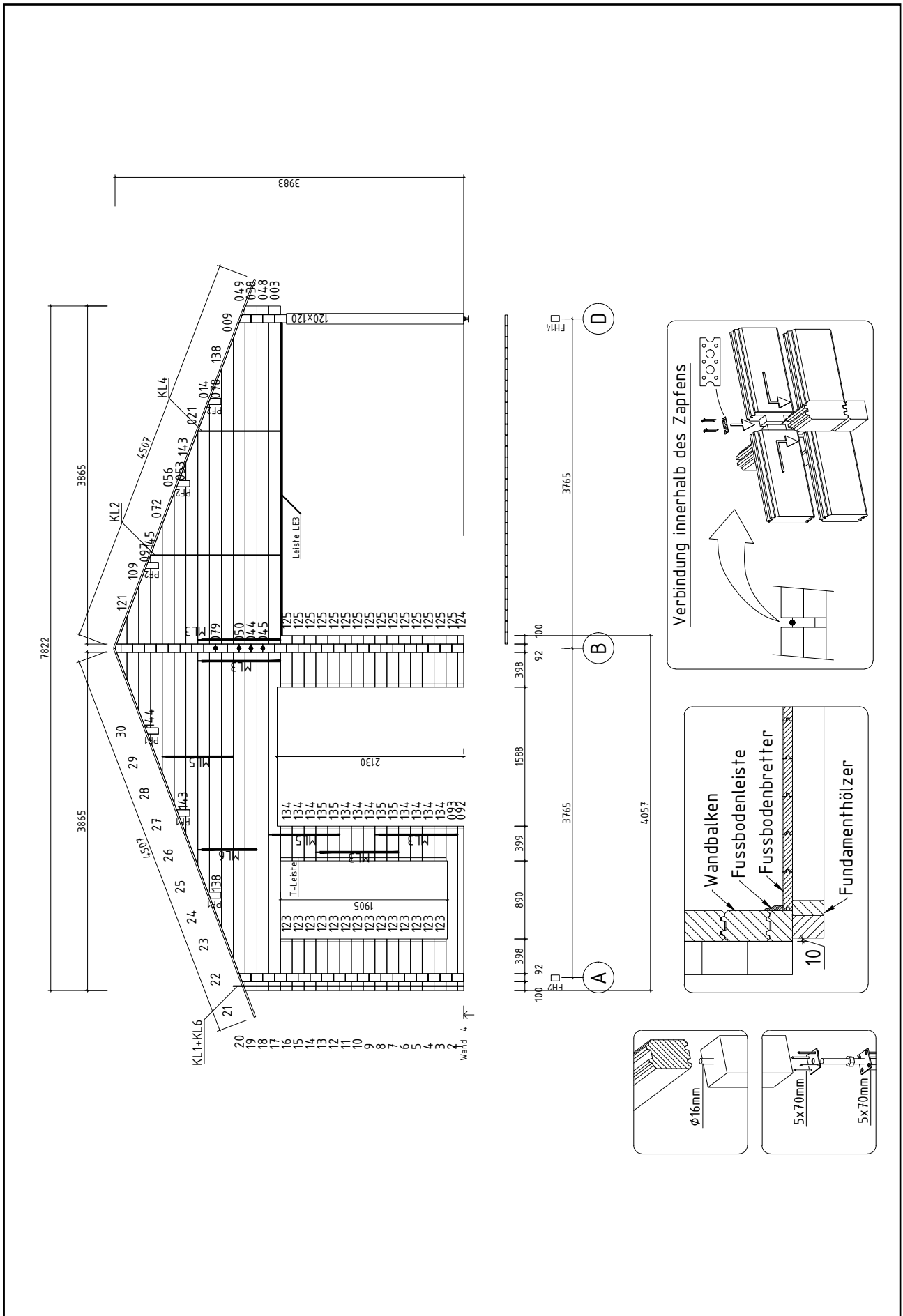

# Wandplan 5 592140

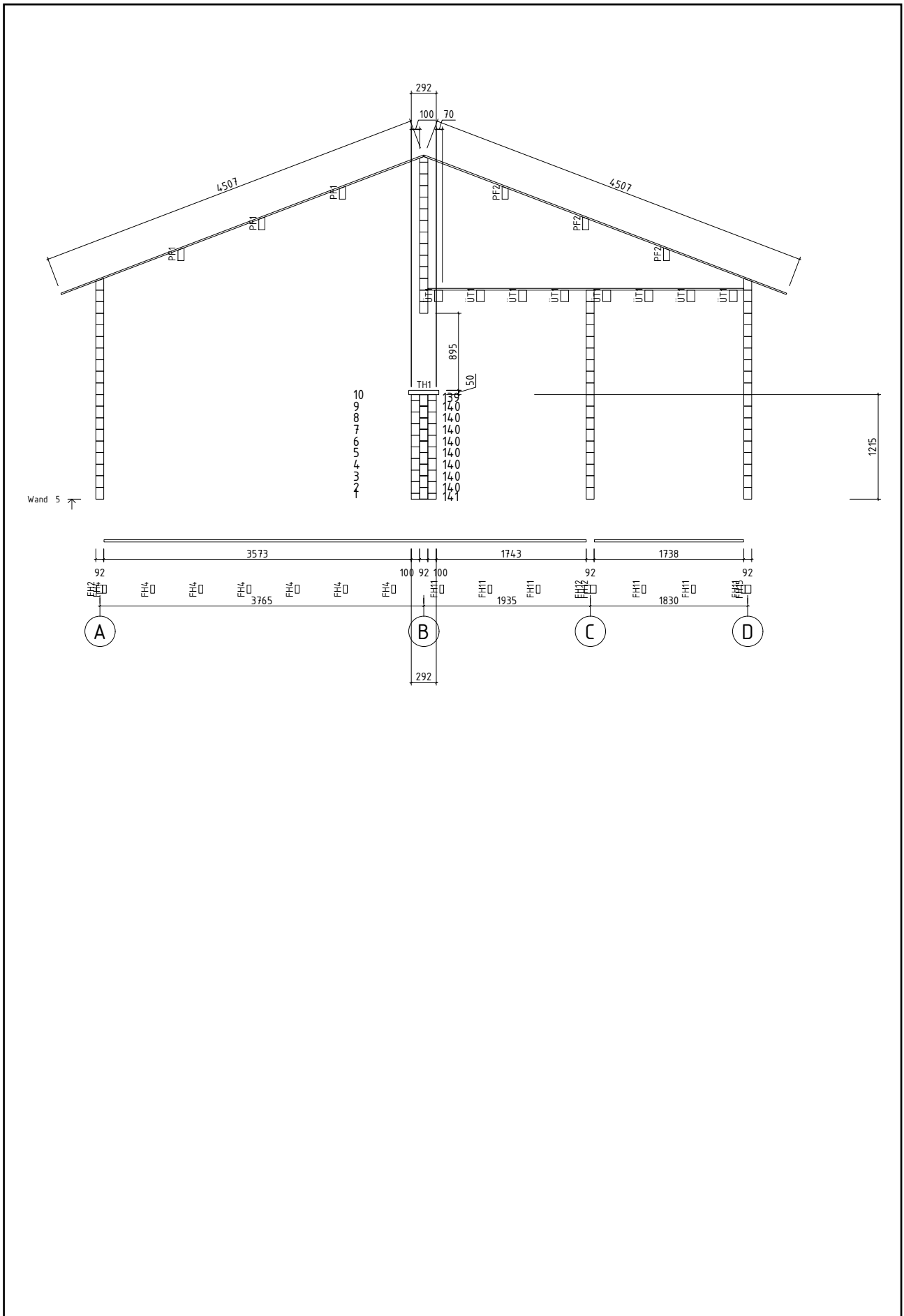

# Wandplan A 592140

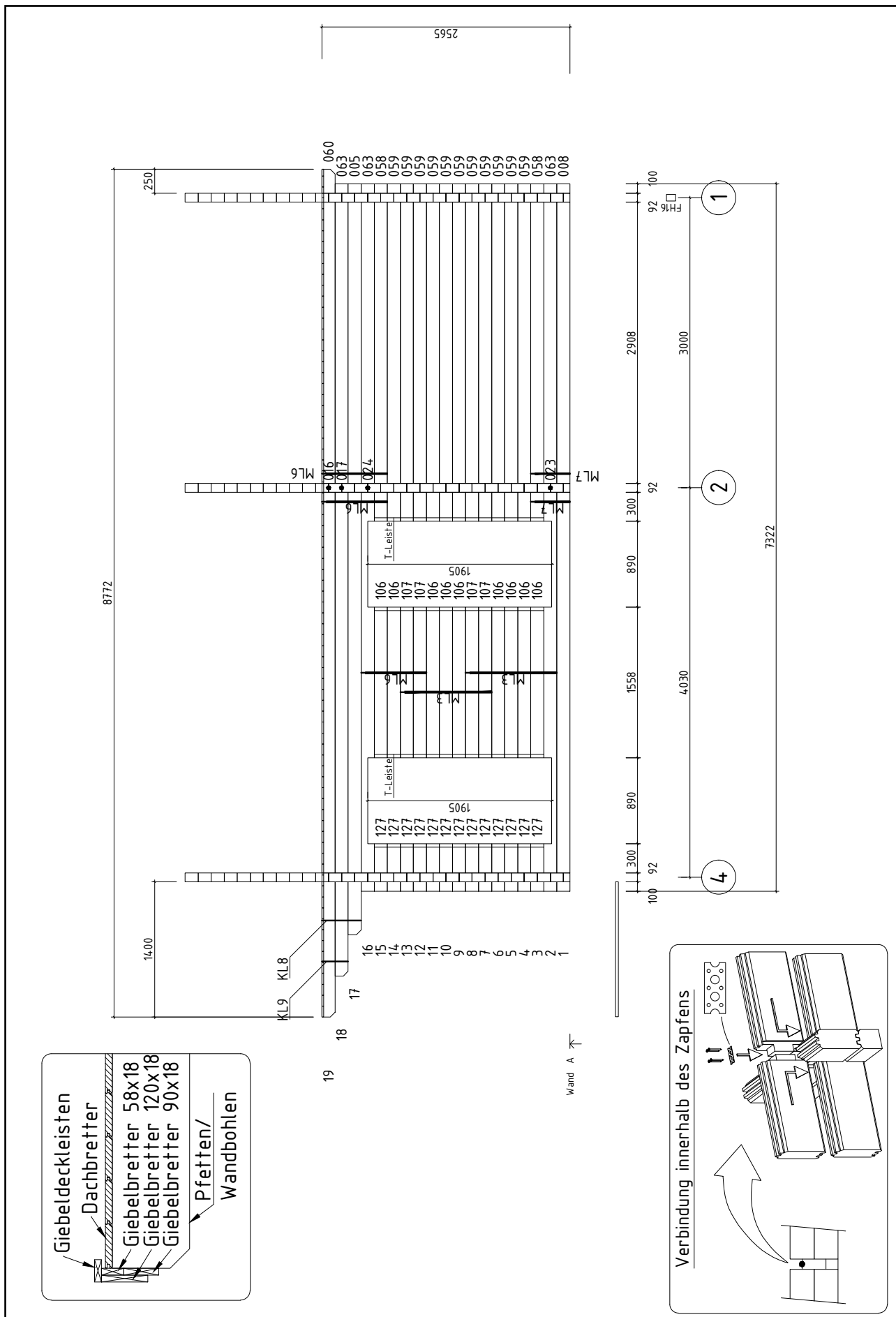





# Wandplan C und D

## 592140

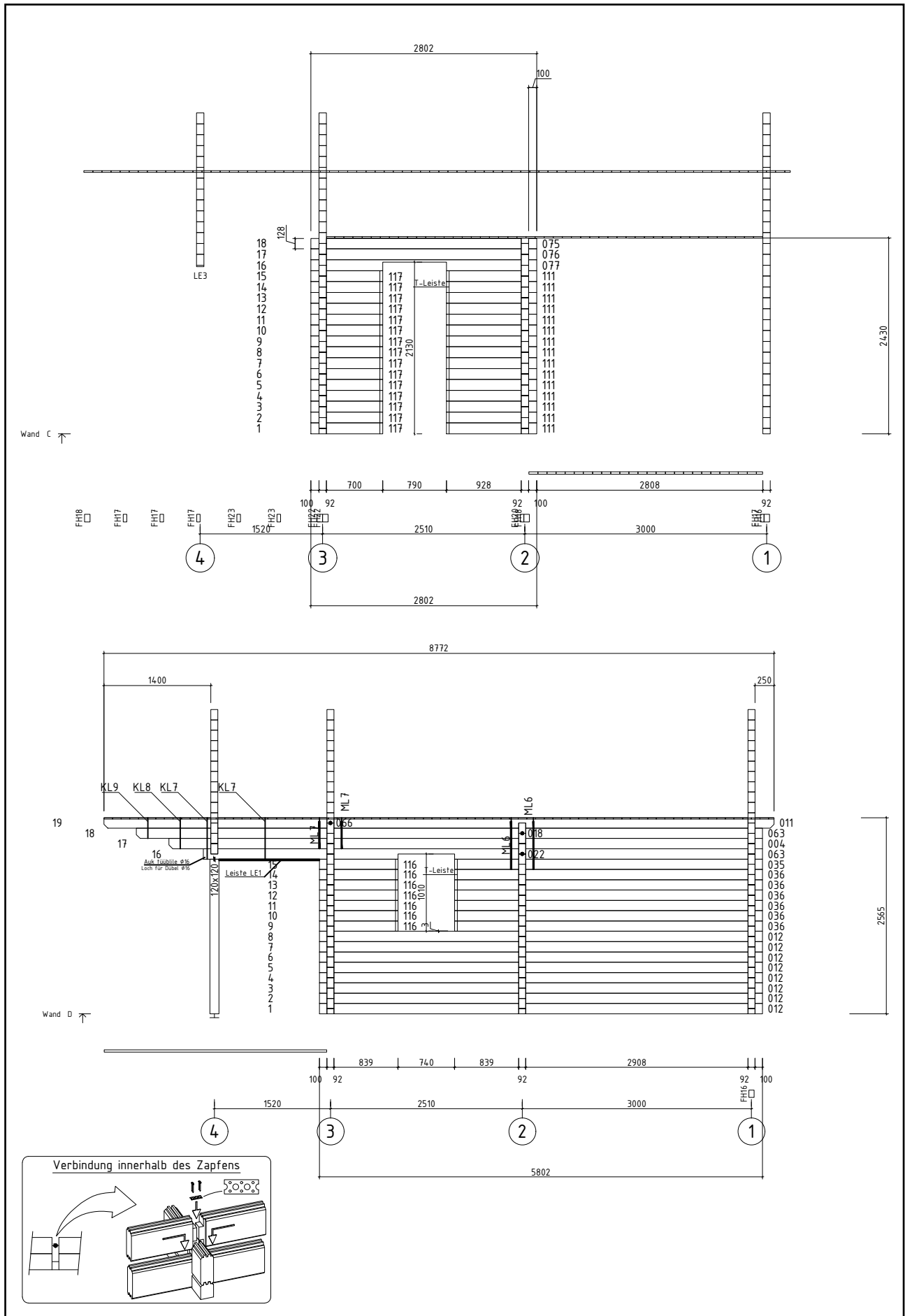

# Details 592140

Montageanleitung für T-Leisten / Installing the door and window supports / Tenderliistu paigaldusjuhend.

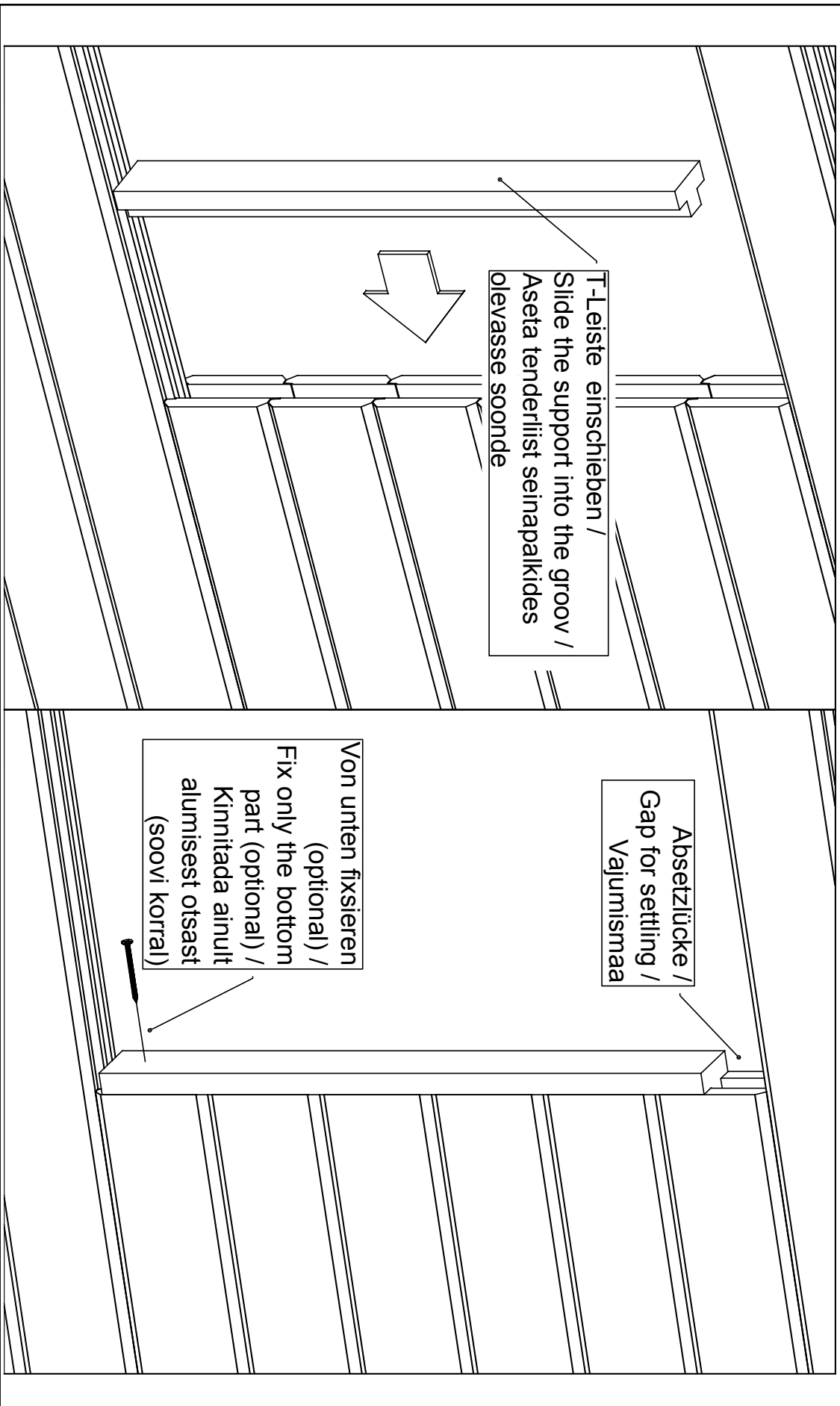

# Details 592140

Vihmaliist / Head flashing / Regenschutz

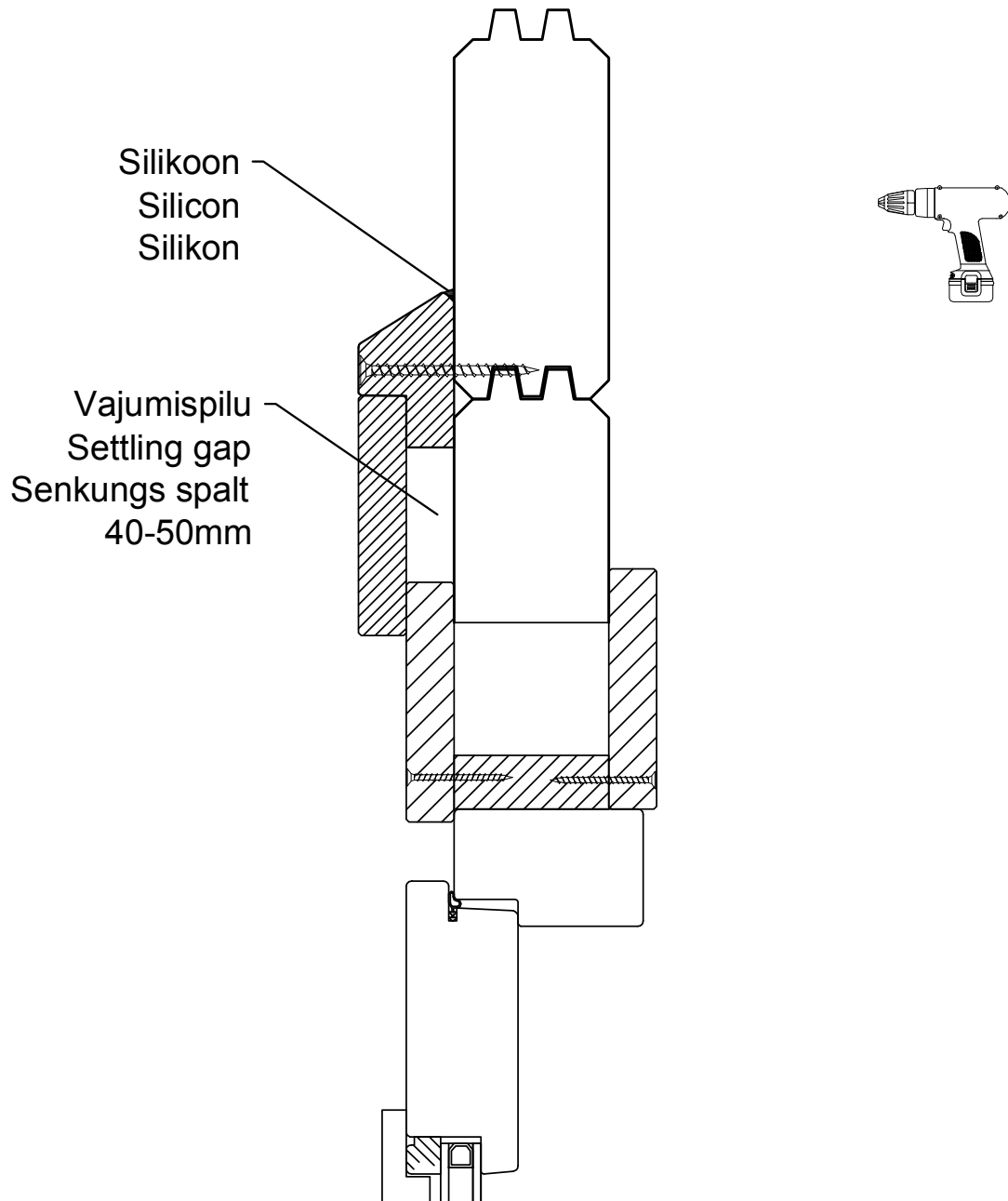

NB!

- Monteerida juhul kui ese on välja toodud maja spetsifikatsioonis!
- Install only if the item is listed in the house specification!
- Nur montieren wenn die Leiste in der Teileliste gezeigt ist!

# Details 592140

Akna tüüp / Fenster typ / ...-dow type - A68  
(GH+ / SH)

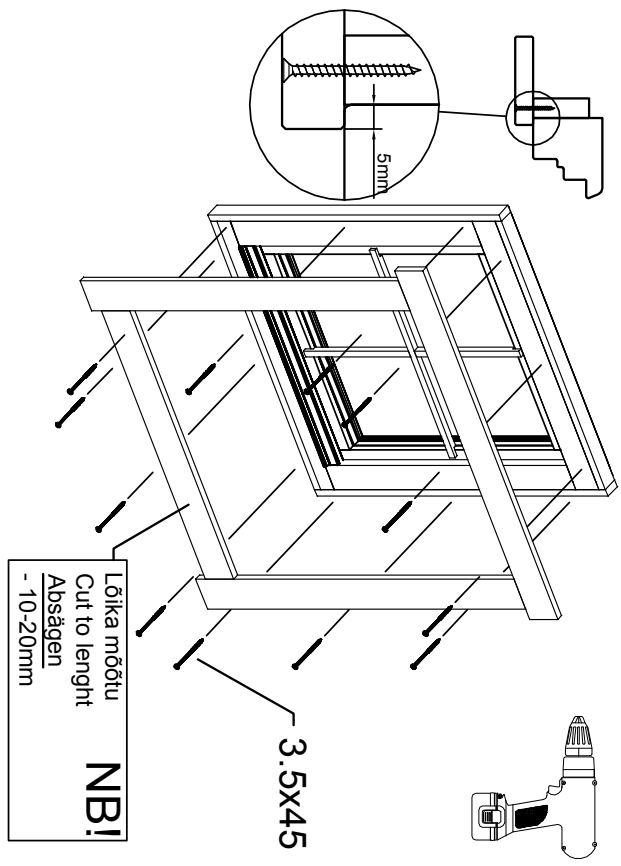
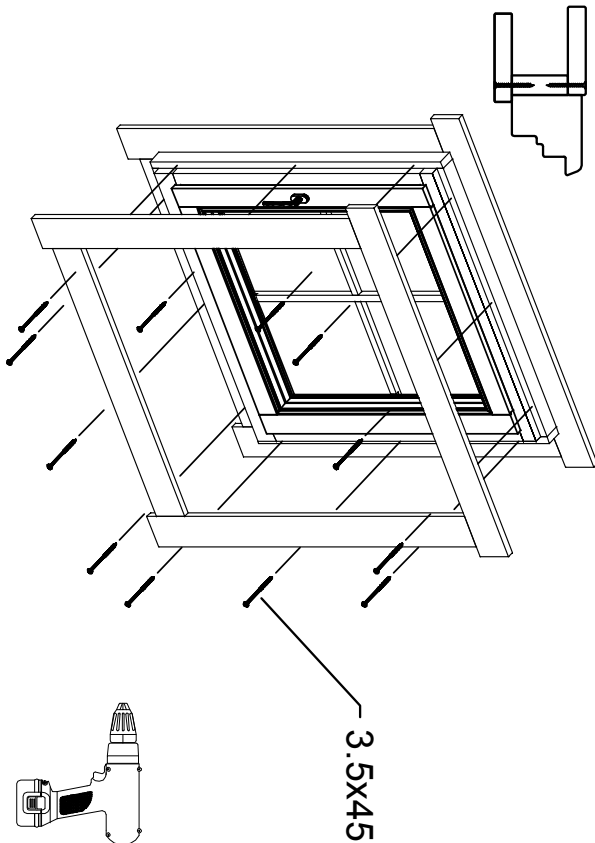
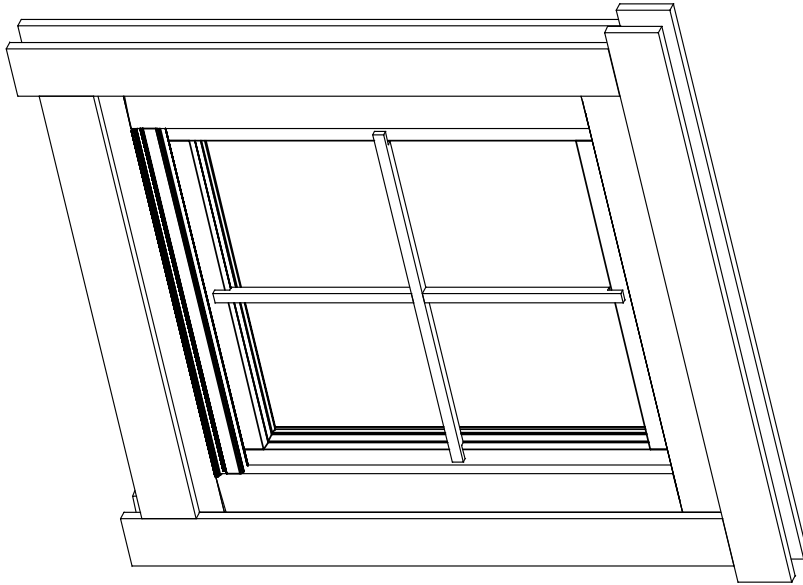

Lõika mõõtu  
Cut to length  
Absägen  
- 10-20mm  
**NBI**