

Technische Daten: Art.-Nr.: 544120

Wandaußenmaß: 360 x 360 cm

Bohlenstärke: 44 mm



Durch Kunden farblich endbehandelt

Kontrolliert durch:

Achtung: Alle angegebenen Maße sind ca.-Maße!

3D-Darstellung und Grundriss 544120

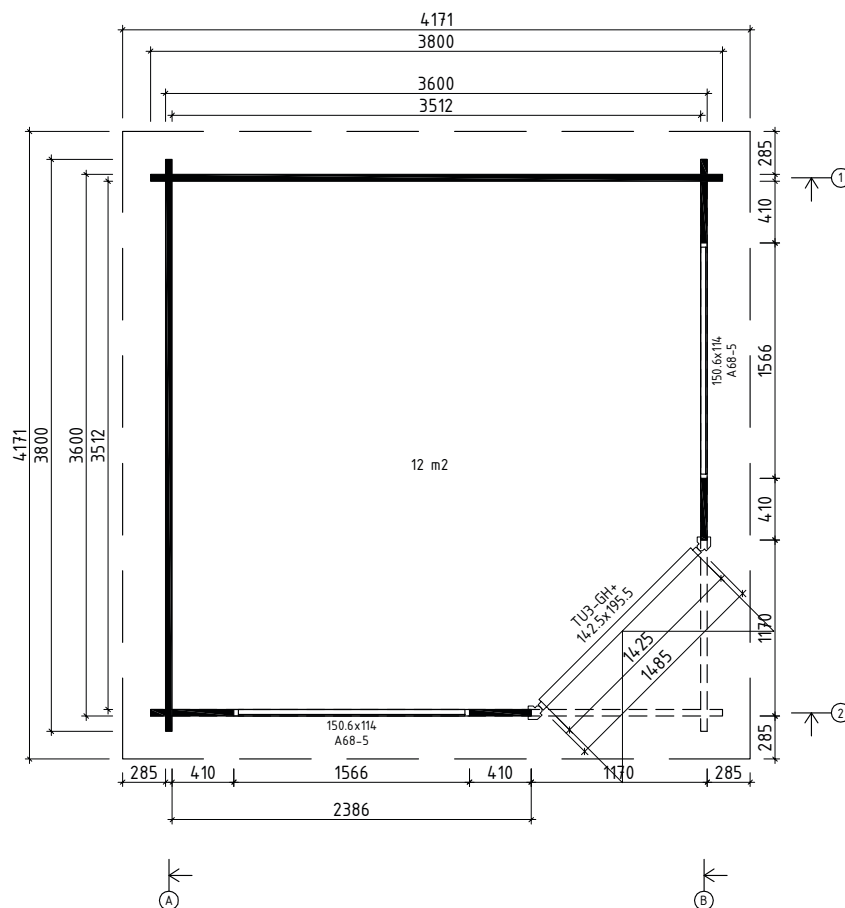
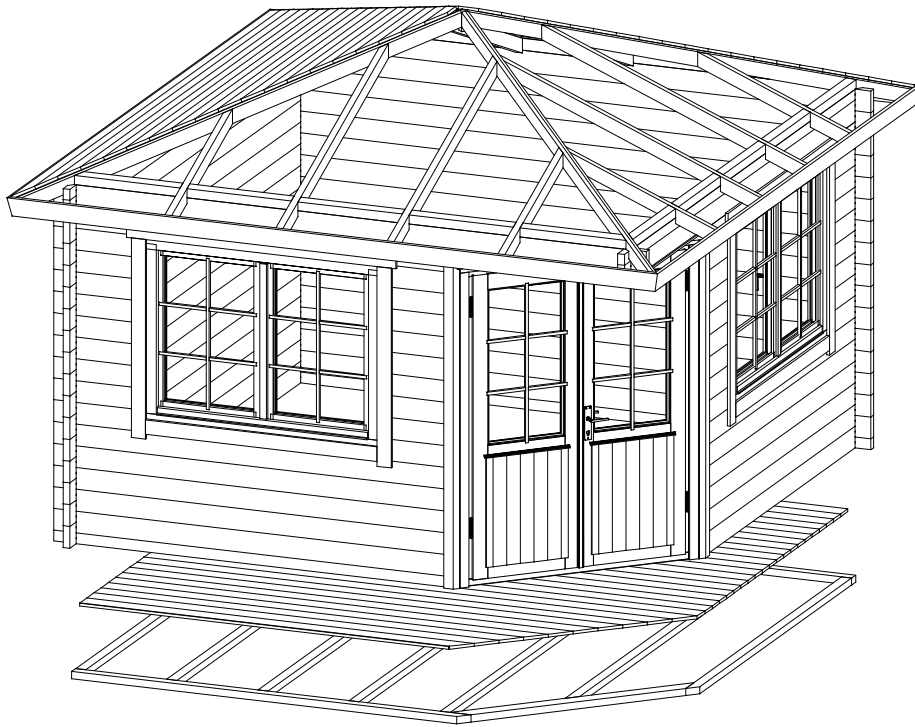

Lagerholzplan und Fundamentplan 544120

Wir empfehlen als Fundament für Ihr Gartenhaus eine vollflächig,
festgegründete gepflasterte oder betonierte Fläche.
Wahlweise ist auch ein Punkt- oder Streifenfundament möglich.

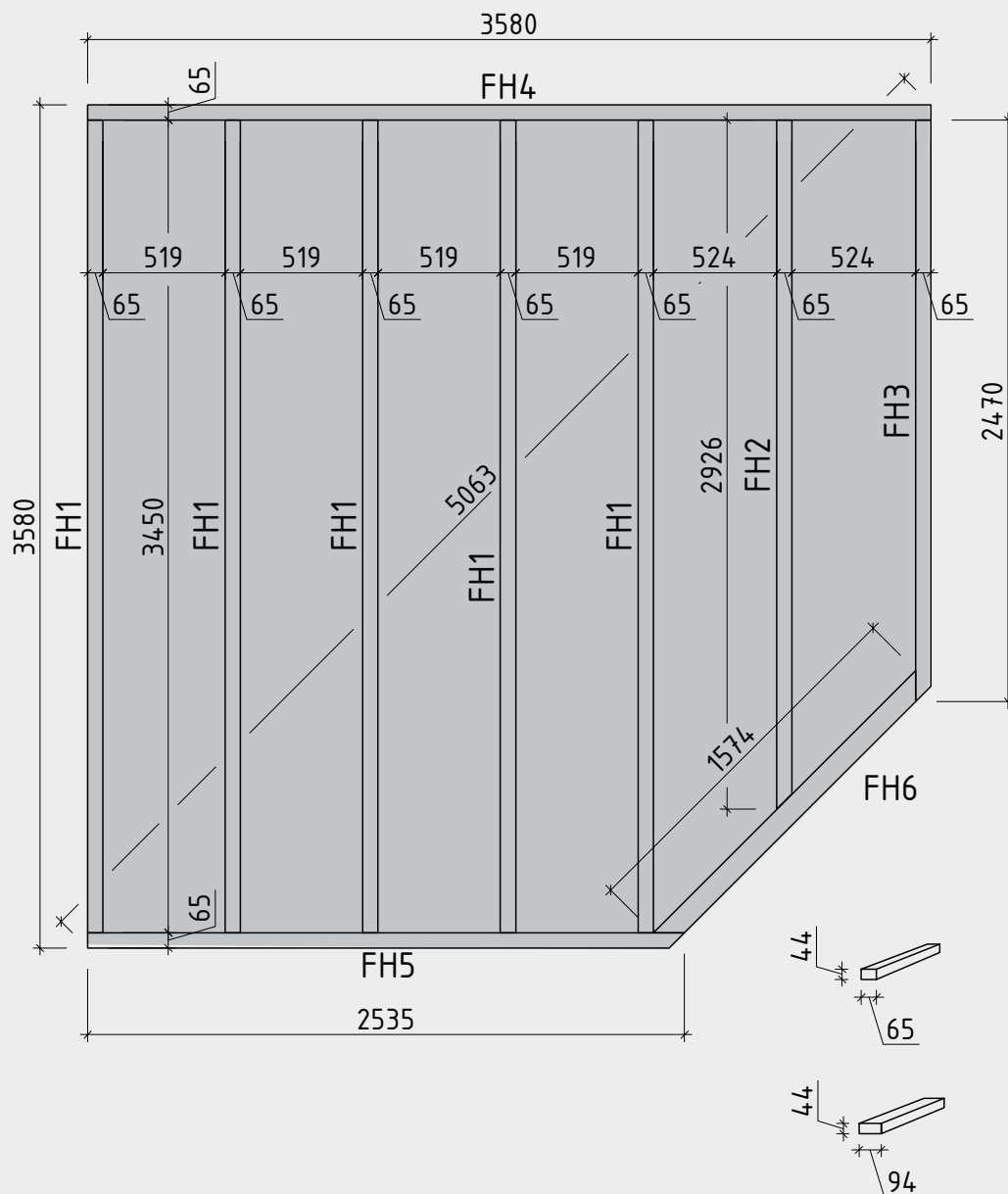



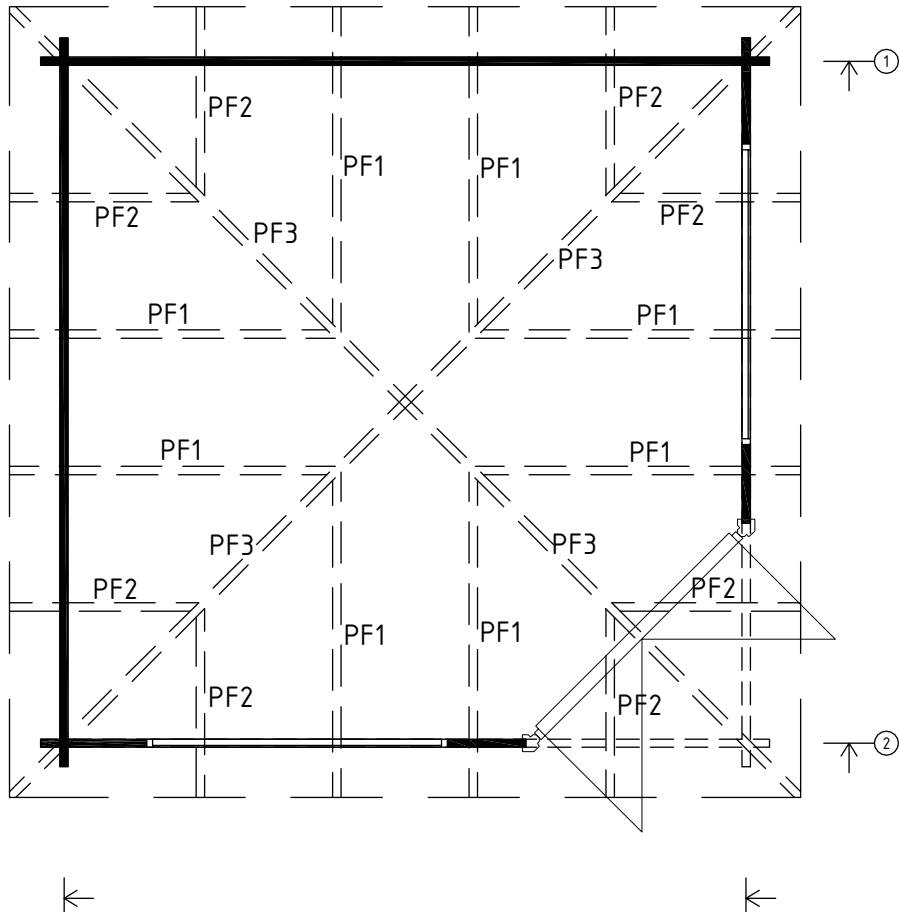





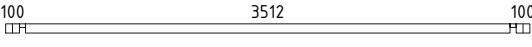
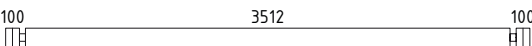
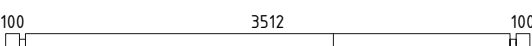
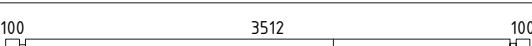
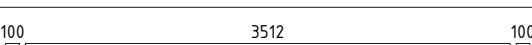
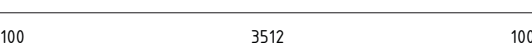
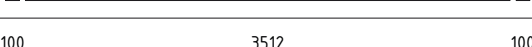
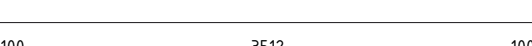

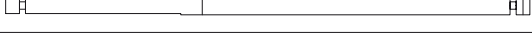

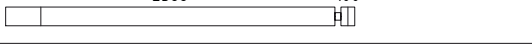

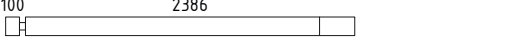
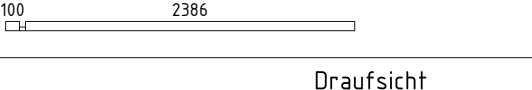
Pfettenplan 544120

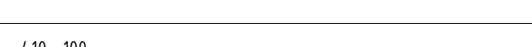



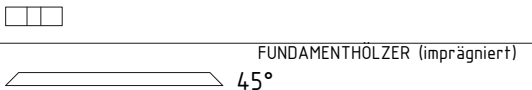
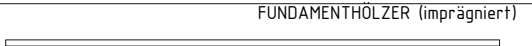
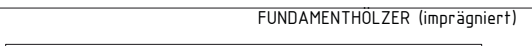



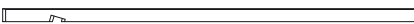

Teileliste 1

544120

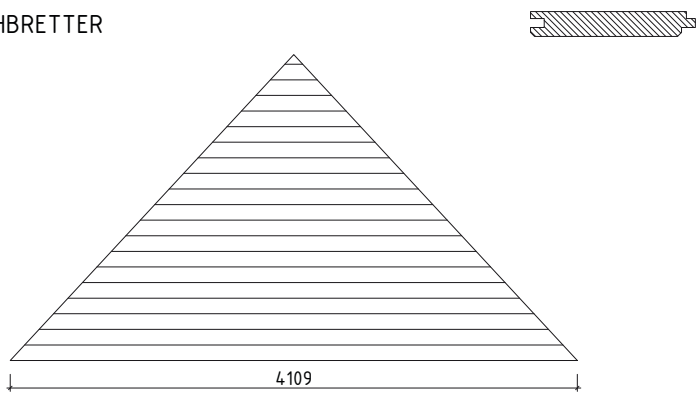
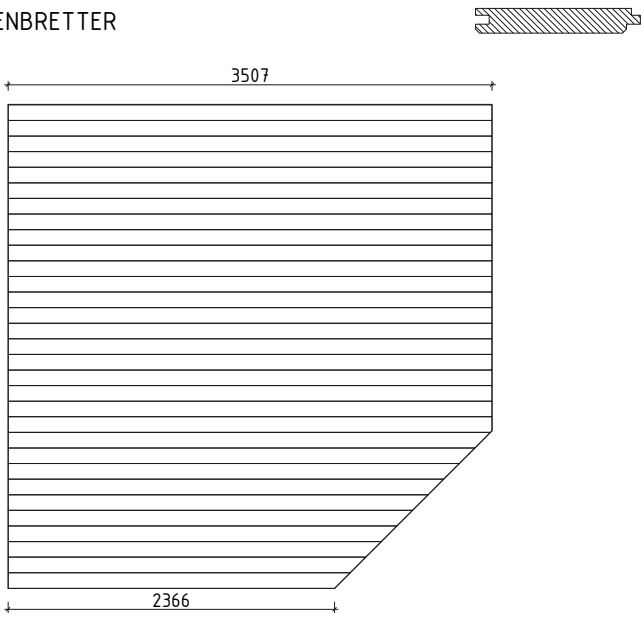
Pos		Stck	Profil (mm)	Länge (mm)
001		1	44x68	3800
002		16	44x135	3800
003		1	44x135	3800
004		1	44x135	3800
005		1	44x135	3800
006		15	44x135	3800
007		1	44x68	3800
008		1	44x68	3800
009		1	44x135	3800
010		1	44x135	2530
011		5	44x135	2530
012		1	44x135	2530
013		5	44x135	2530
014		1	44x68	2530
015		4+4	44x74	679
016		12	44x74	668
017		9	44x135	554
018		8	44x135	554
019		13	44x135	410
020		4	44x135	410
FH6		1	94x44	1574
FH4		1	65x44	3580
FH1		5	65x44	3450
FH2		1	65x44	2926
FH5		1	65x44	2535

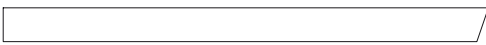









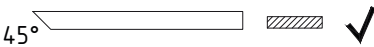



Teileliste 2

544120

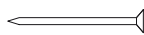
Pos		Stck	Profil (mm)	Länge (mm)	
FH3	FUNDAMENTHÖLZER (imprägniert)  45°	1	65x44	2470	
PF3	PFETTEN 	4	44x94	3013	
PF1	PFETTEN 	4+4	44x85	1847	
PF2	PFETTEN 	4+4	44x85	1080	
	DACHBRETTER 	4	113x18		
	FUSSBODENBRETTER 	21	113x18	21+1 sirged/ ohne Ecke 11 nurk 45°/ mit Ecke	
	FUSSBODENLEISTE 	✓	18x40	14,0 lfm	
T1-1	TRAUFENBRETTER 120X18 	✓	4	120x18	4210
	Zentralverbindungselement (Dach) 	1	44x44	90	
P9L-1	ECKTÜR- linke Türpfoste 90 	1	90x90	2045	
P9R-1	ECKTÜR- rechte Türpfoste 90 	1	90x90	2045	
DzT 40-1	ECKTÜR- Deckbrett zum Tür 40 	1	18x40	1585	

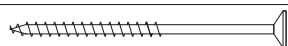
Teileliste 3

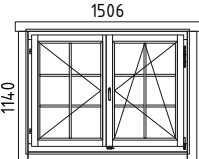
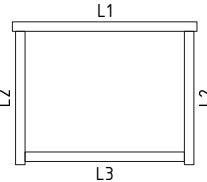
544120

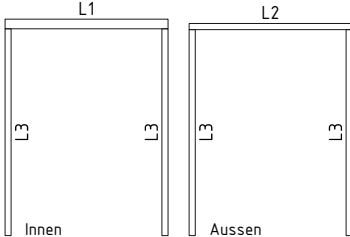
Pos		Stck	Profil (mm)	Länge (mm)
VK-1	ECKTÜR- Verkleidungsleisten für Vordachelement 	2	58x12	1110
VE1	ECKTÜR- Vordachelement 1435x745 	1		
SH	Schlaghölzer 	3		
ML1	Metallstange 	4	D10	1170
KL1	Gewindestange M8 	3	M8	2000
KL2	Gewindestange M8 	3	M8	258
	Mutter M8 U-Scheibe Ø25 	6	M8	
	Befestigungsmutter M8 	3	M8	
NG1	NÄGEL 2.5x50 Dachbretter Fussbodenbretter 	1208		
SR01	SCHRAUBEN 3.0x30 Fussbodenleiste 	30		
SR03	SCHRAUBEN 3.5x45 Deckbrett, Vordachelement Verkleidungsleisten, Traufenbretter Fenster- und Türleisten 	130		
SR10	SCHRAUBEN 5.0x100 Fundamenthölzer Wandbalken pos 015, 016, 004 und 008 	87		
SR09	SCHRAUBEN 5.0x70 pos 011 und 014 (1. Bohlenreihe neben die Tür) Pfetten PF1, PF2, PF3 	40		
	FENSTER 1506x1140   A68-5 L1 18x90 L=1745mm 2 Stck. L2 18x90 L=1260mm 4 Stck. L3 18x90 L=1505mm 2 Stck. ✓ DIN 1xrechts/1links	2		
	TÜR 1425x1955   TU3-GH+ L1 18x90 L=1540mm 1 Stck. L2 18x58 L=1540mm 1 Stck. L3 18x58 L=1955mm 4 Stck. ✓ DIN rechts	1		
	✓ - bitte selber anpassen (falls nötig)!			

Wandplan 1 und 2 544120

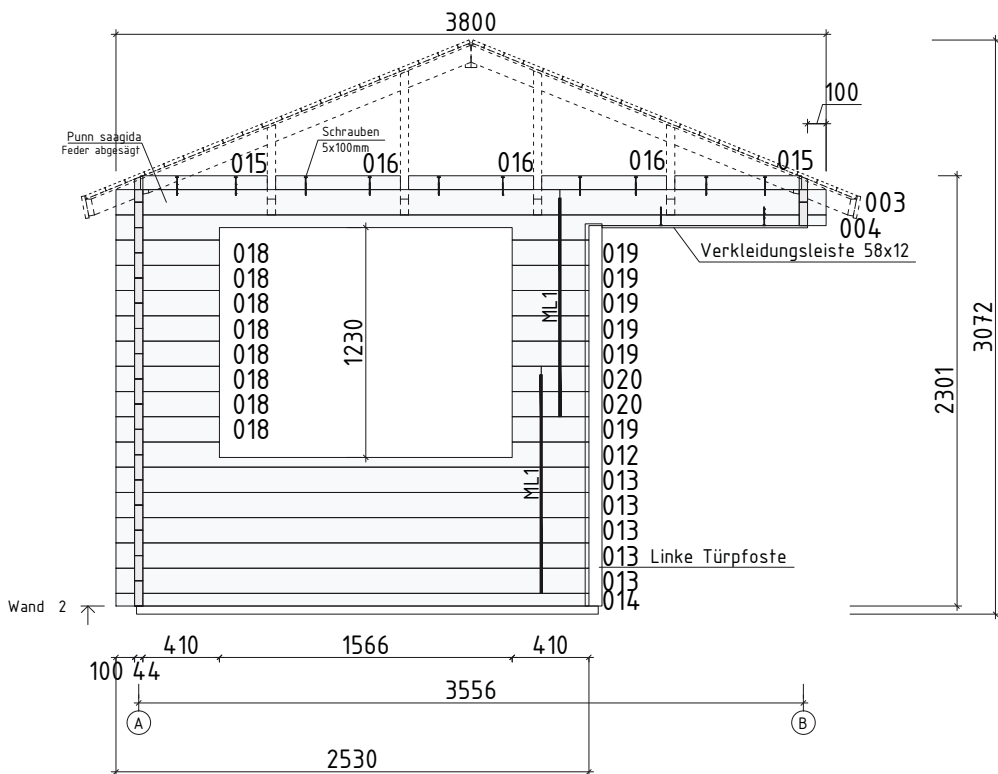
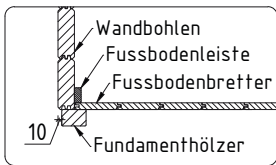
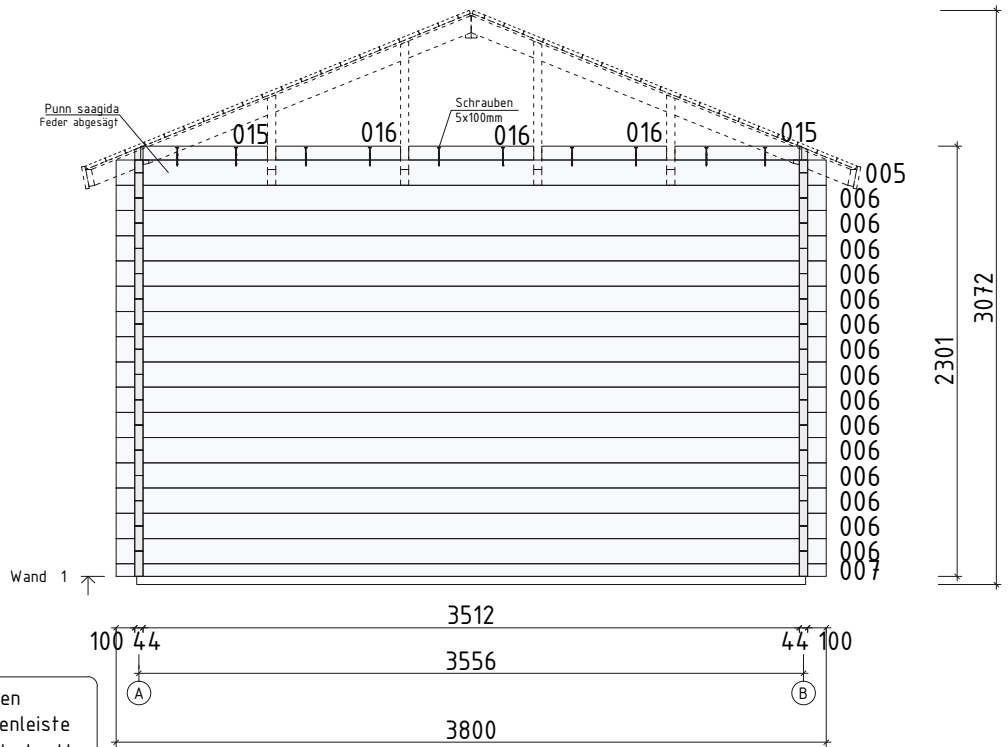

Wandplan A 544120

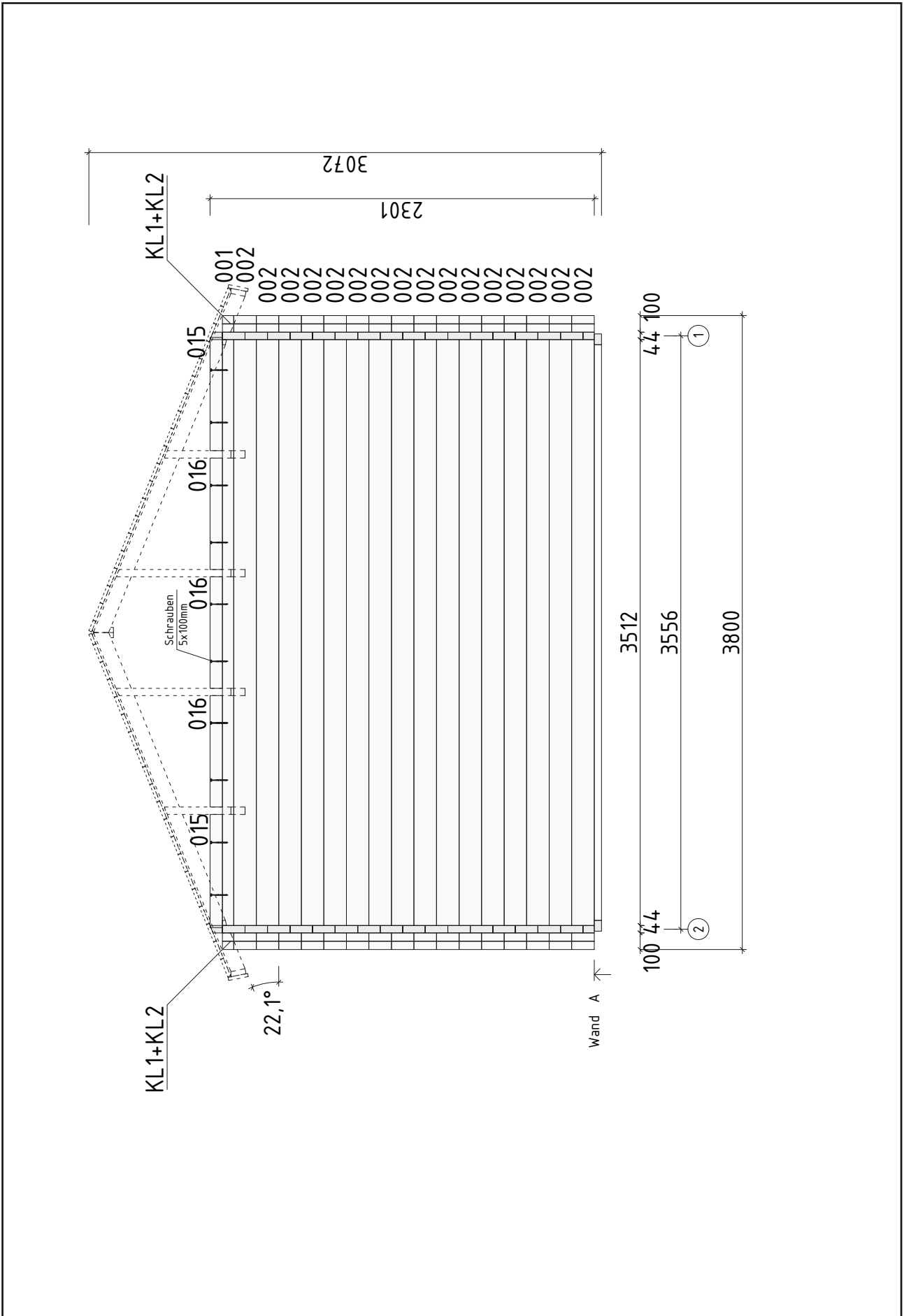

Wandplan B 544120

