

# Technische Daten: Art.-Nr.: 870610

Wandaußenmaß: 360 x 360 cm

Bohlenstärke: 70 mm



Nordkap 70-C, durch Kunden farblich endbehandelt.

Kontrolliert durch:

Achtung: Alle angegebenen Maße sind ca.-Maße!

# 3D-Darstellung und Grundriss 870610

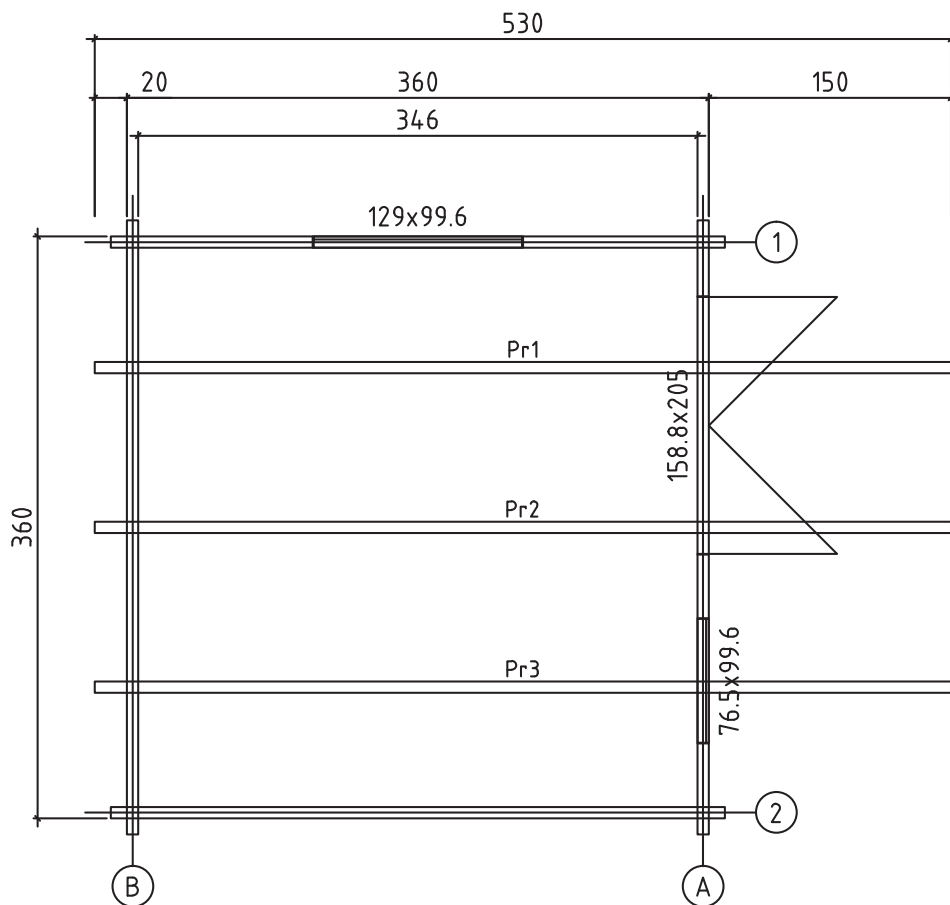
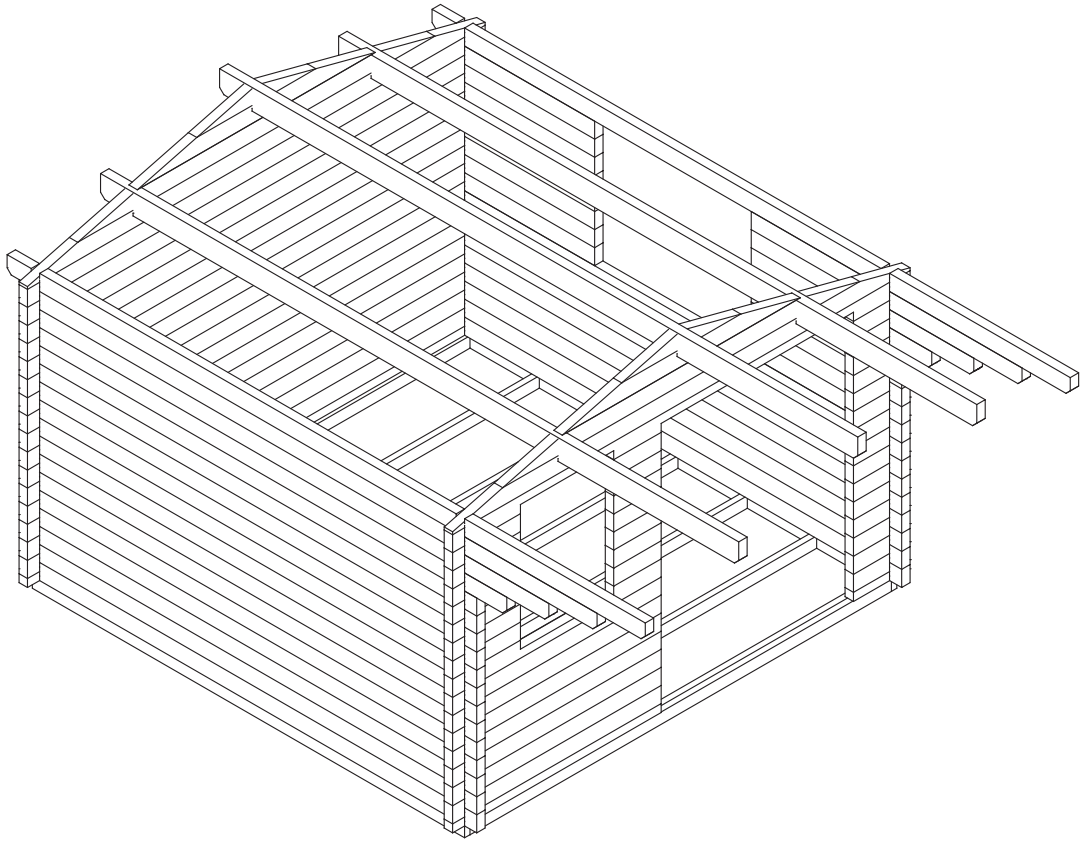





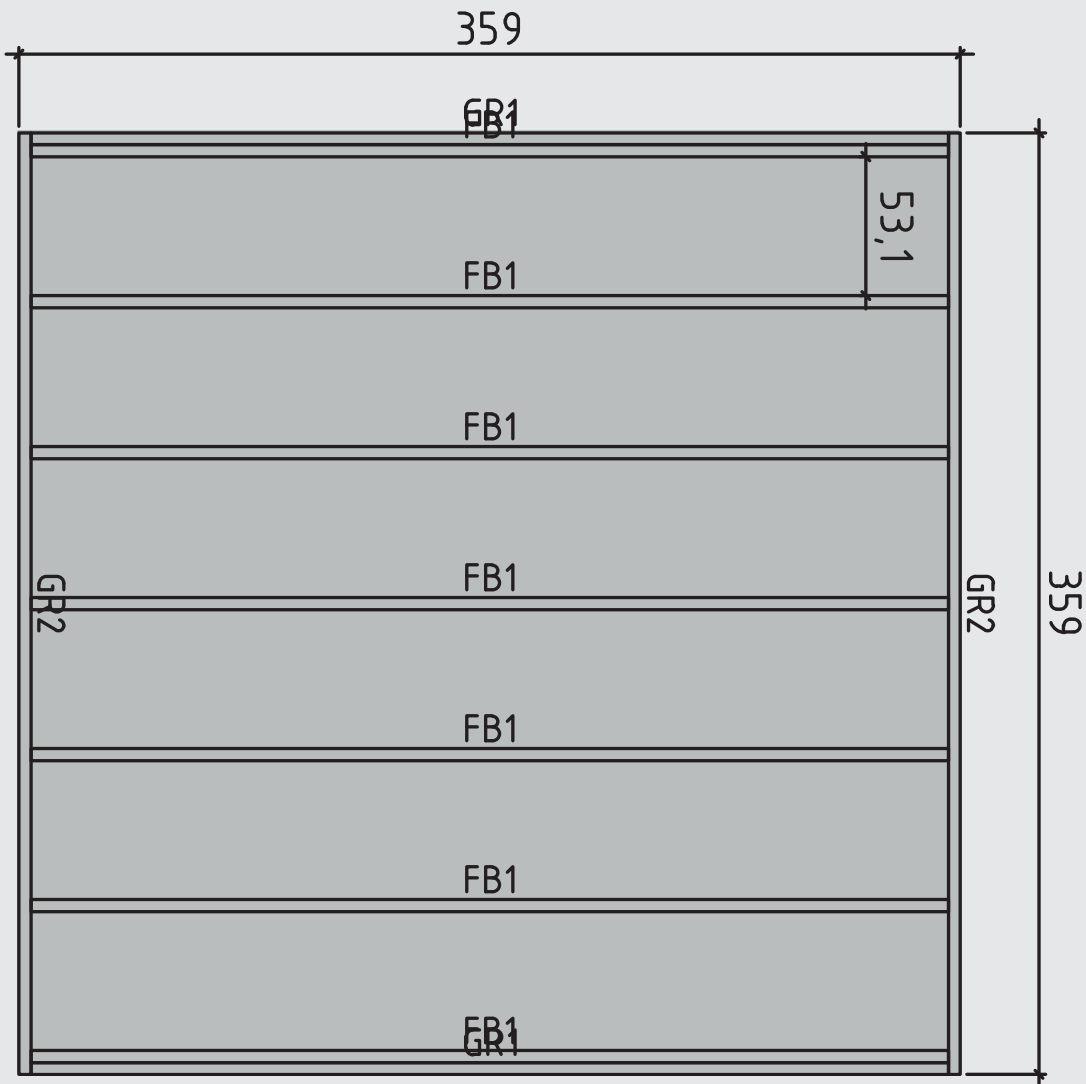





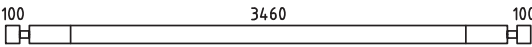
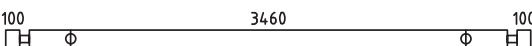
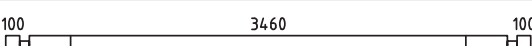
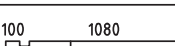
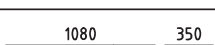
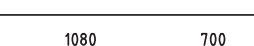
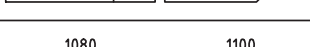

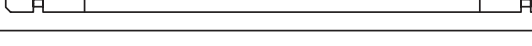
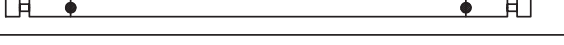
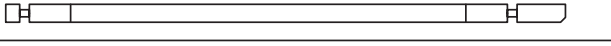
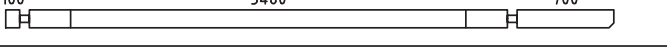
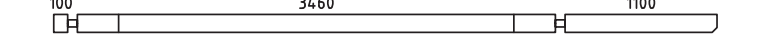
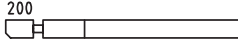
# Lagerholzplan und Fundamentplan 870610

Wir empfehlen als Fundament für Ihr Gartenhaus eine vollflächig,  
festgegründete gepflasterte oder betonierte Fläche.  
Wahlweise ist auch ein Punkt- oder Streifenfundament möglich.

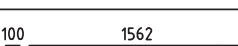

# Teileliste 1

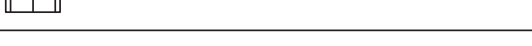
## 870610

Pos			Profil (mm)	Lenght (mm)
001		2	70x130	3800
002		1	70x130	3800
003		17	70x130	3800
004		13	70x130	1250
005		1	70x130	1500
006		1	70x130	1850
007		1	70x130	2250
008		1	70x130	5300
009		1	70x130	3800
010		1	70x130	4050
011		1	70x130	4400
012		1	70x130	4800
013		1	70x130	5300
014		1	70x65	1732
015		1	70x65	470
016		1	70x130	1732
017		15	70x130	470
018		6	70x130	1732
019		1	70x130	1732
020		7	70x130	563
021		7	70x130	394
022		1	70x130	3800
023		1	70x130	3800
024		7	70x122	464
025		1	70x130	1917





# Teileliste 2

## 870610

Pos			Profil (mm)	Lenght (mm)
026			70x130	1977
027			70x122	464
028			70x65	3800
029			70x130	3800
030			70x130	3800
031			70x130	1917
032			70x130	1977
GR2		GROUNDFRAME	45x90	3590
GR1		GROUNDFRAME	45x90	3500
FB1		FLOORBEAMS	45x90	3500
Pr1		Purlins	70x170	5300
Pr2		Purlins	70x170	5300
Pr3		Purlins	70x170	5300
	WINDOW 1290x996			1
	WINDOW 765x996			1
	DOOR 1588x2050			1
1	Screws/Schrauben/Vis 5x100 mm- For fixing first row of wall logs /Fixierung des ersten Bohlenkranzes/Pour fixer les lamesde plancher			6
2	Nails/Nägel/Clous 2.5x50 - For fixing floorboards/ Befestigung Fussbodenbretter/Pour fixer les lames de plancher			280
3	Nails/Nägel/Clous 2.5x50 - For fixing roofboards/ Befestigung Dachbretter/Pour fixer les voliges			370
4	Nails/Nägel/Clous 2.5x50 - For fixing floor edge trims/ Befestigung Fussleisten/Pour fixer les plinthes du plancher			30
5	Nails/Nägel/Clous 2.5x50 - For fixing roofing felt fillet/ Befestigung giebelabschlussbrett/Pour fixer la latte de finition de la couverture			20
6	Screws/Schrauben/Vis 2,5x50 mm- For fixing roof side boards and roof edge reinforcement Befestigung Traufenbretter und Traufenteisten Pour fixer les planches de rive et le tasseau de refront			44
7	Screws/Schrauben/Vis 2,5x50 mm- For fixing fascia boards and diamonds/ Befestigung Giebelblende und Raute Pour fixer les planches de rive et le diamant			28
8	Screws/Schrauben/Vis 2,5x50 mm- For fixing fwindow and door trims/ Befestigung Fenster und türen/ Pour fixer les croisillons des fenetres et des portes			44











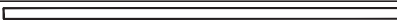







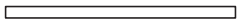

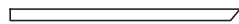

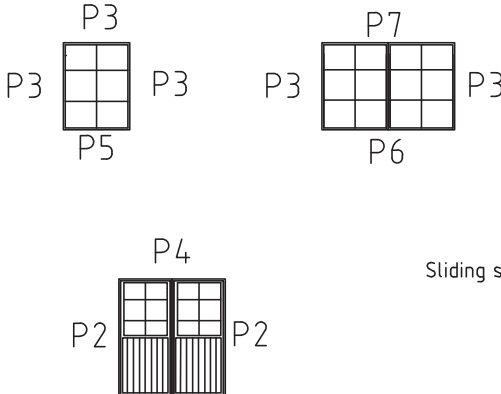

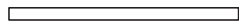
# Teileliste 3

## 870610

Pos			Profil (mm)	Lenght (mm)
9	Metal storm Brace/Gewindestange/Tige filetee 10 mm 		5	
10	Shim,Nuts/Mutter ,U-Scheibe/ECrou;Rondelle 10 mm For fixing storm braces/ Pour fixer les anti tempete/ Für Sturmleisten Pour fixer les croisillons des fenetres et des portes    		5 /5	
	Metal storm Brace/Gewindestange/Tige filetee 10 mm			
	KL1 M10 2,76 <i>m</i> 1 Screws 180 10 pcs.			
	KL2 M10 2,31 <i>m</i> 4 Plastic caps 5 pcs.			

# Teileliste 4

## 870610

POS	ST.	B	H	L	Teileliste		
FB1	Vt. spetsi					FUNDMENTHOLZER	
F1	12 m <sup>2</sup>	28		3455		FUSSBODENBRETTER	40/31/26
PR	3	70	170	5300		DACHBALKEN	
RB1	22,5 m <sup>2</sup>	20		2120		DACHBRETTER	122/94/78
R1	2	20	120	5300	<i>Vaata katuse kaldenurka</i> 	Traufenbretter	
R2	2	45	65	5300	<i>Vaata katuse kaldenurka</i> 	Traufenbretter	
R3	4	20	120	2300	<i>Vaata katuse kaldenurka</i> 	Giebelabschlussleiste	
R4	4	20	90	2300		Giebelabschlussleiste	
WN07	1	765	996		 <p>Sliding slats 30x30x1900 mm - 2 pcs. 30x30x800 mm - 2 pcs.</p>		
WN13	1	1290	996				
DR16	1	1588	2050				
P1	15m	20	40			Fußbodenleiste	
P2	2+2	20	90	2030		Türleiste DR16	
P3	10	20	90	1100		Fensterleiste WN13; WN07	
P4	1+1	20	90	1890		Türleiste DR16	
P5	1+1	20	90	725		Fensterleiste WN07	
P6	1+1	20	90	1250		Fensterleiste WN13	
P7	1+1	20	90	1590		Fensterleiste WN13	

# Detailzeichnungen 870610

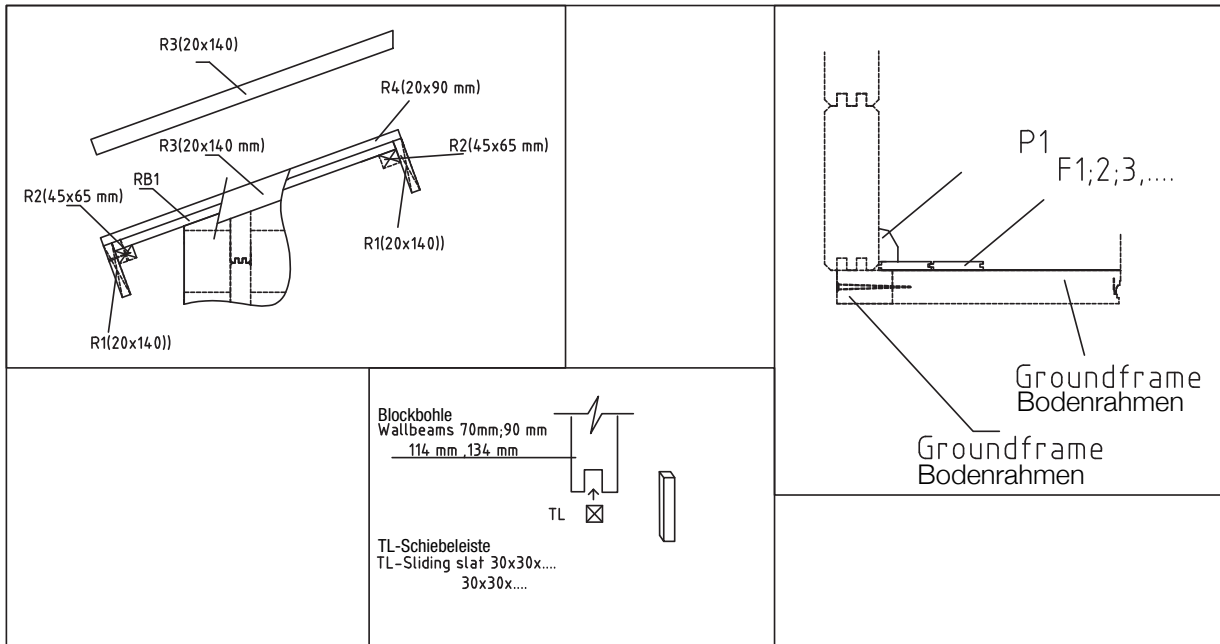

## Tighting system of wallbeams Dichtungssystem der Blockbohlen

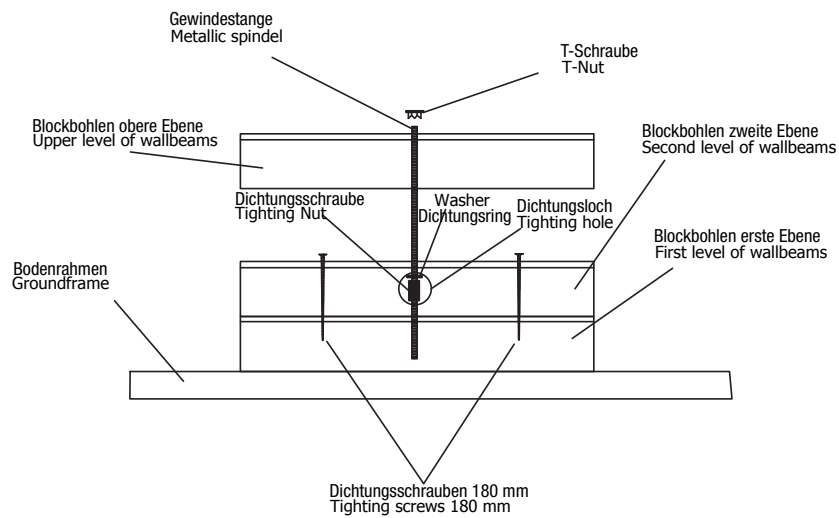



# Wandplan 1 und 2 870610

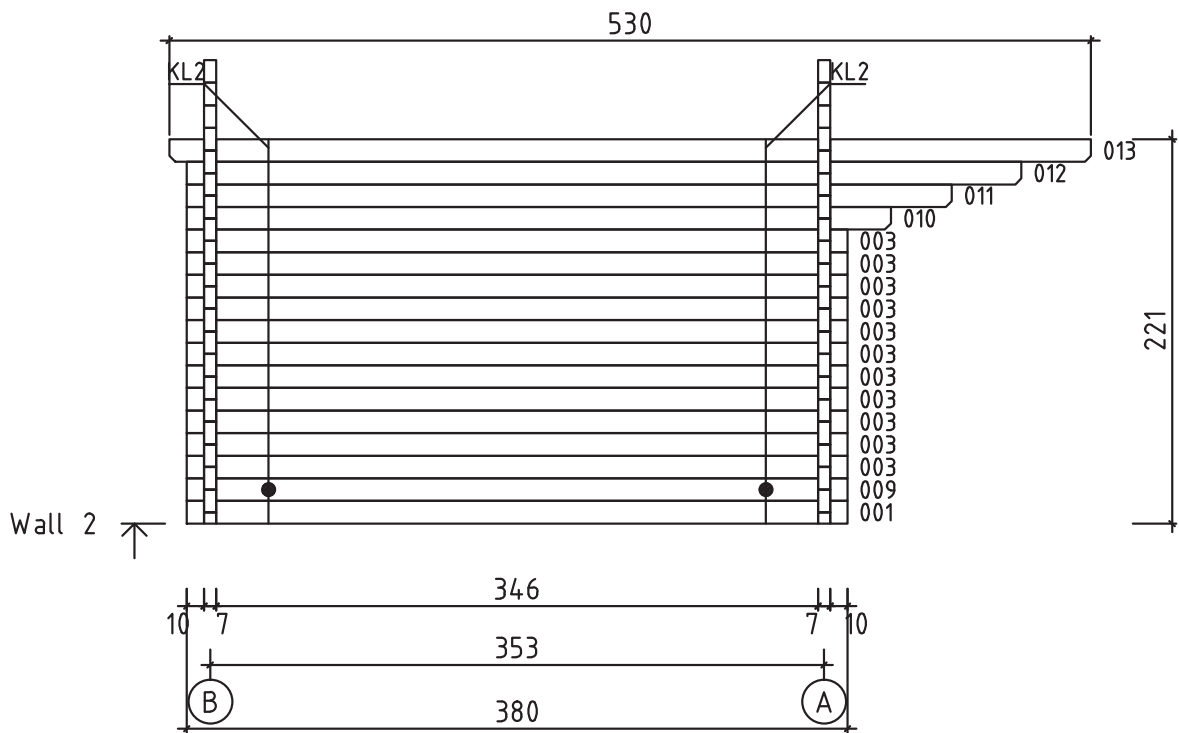
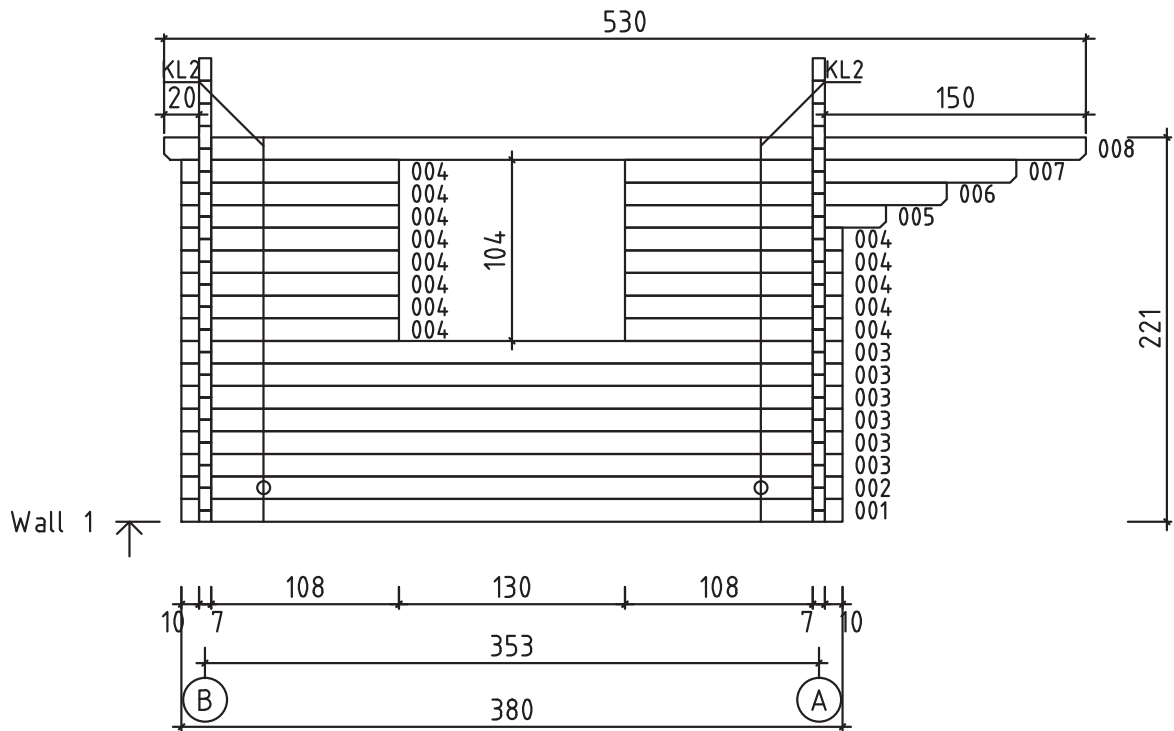

# Wandplan A und B 870610

