

Technische Daten: Art.-Nr.: 871130

Wandaußenmaß: 600 x 600 cm

Bohlenstärke: 70 mm



Lapland 70-B, durch Kunden farblich endbehandelt

Kontrolliert durch:

Achtung: Alle angegebenen Maße sind ca.-Maße!

3D-Darstellung und Grundriss 871130

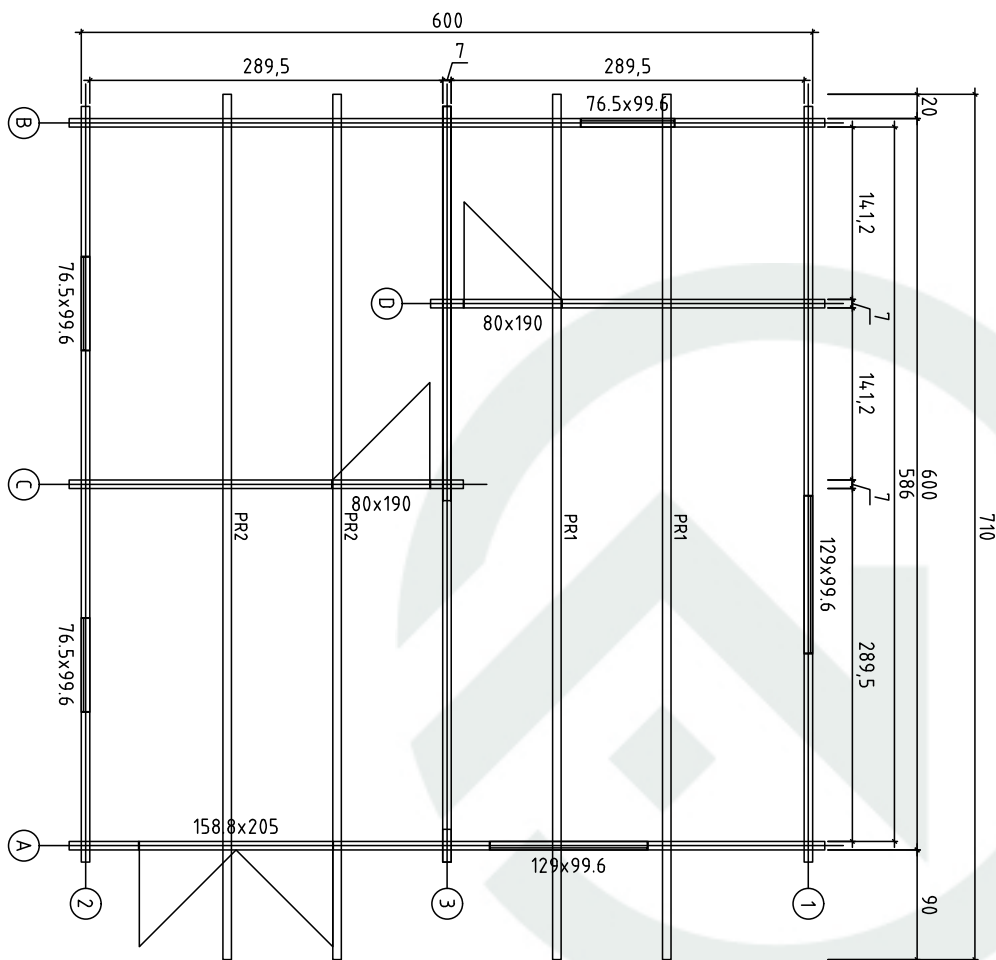
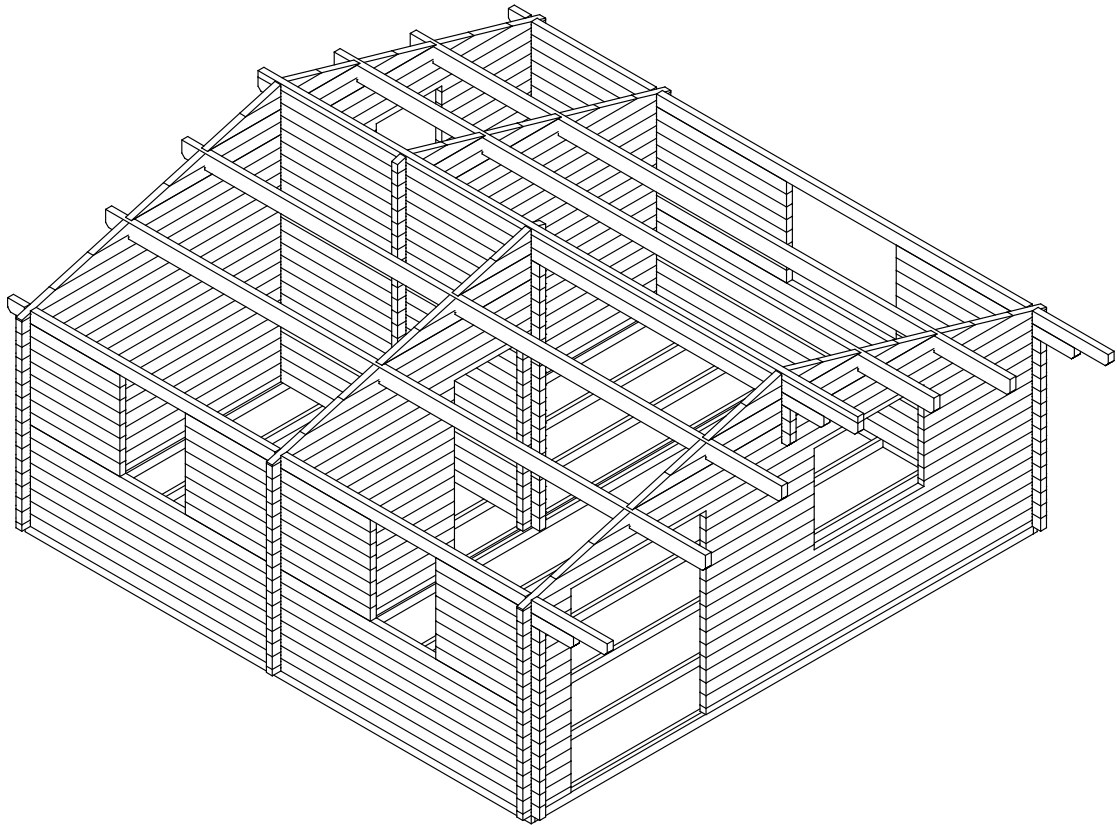

Lagerholzplan und Fundamentplan 871130

Wir empfehlen als Fundament für Ihr Gartenhaus eine vollflächig festgegründete, gepflasterte oder betonierte Fläche.
Wahlweise ist auch ein Punkt- oder Streifenfundament möglich.

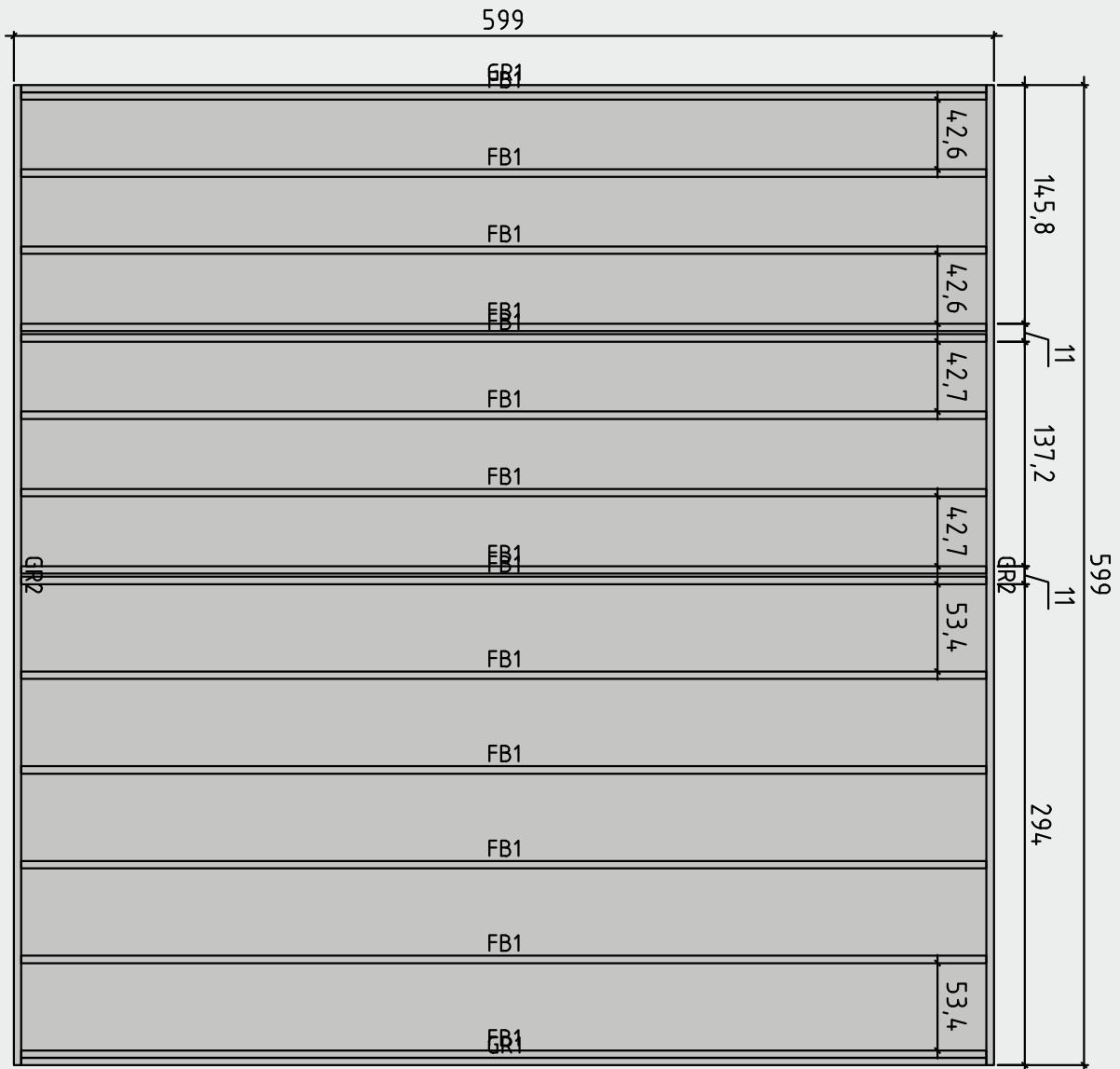









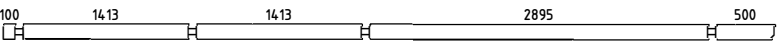
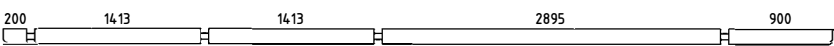
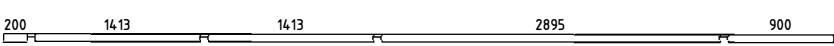

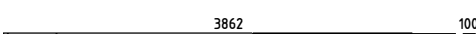

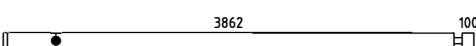
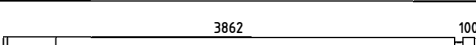
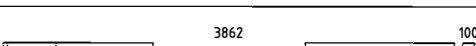
Teileliste 1

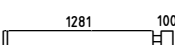
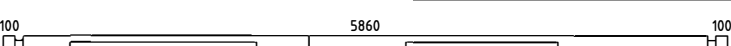
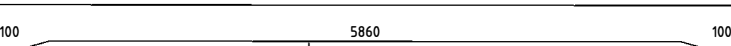
871130



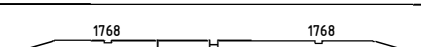
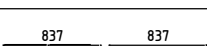
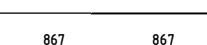
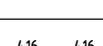
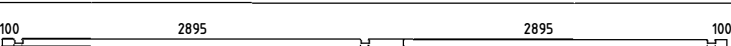
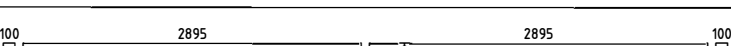

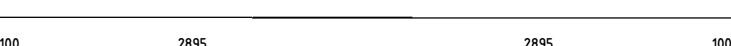
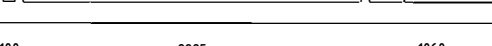



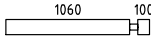

Pos			Profil (mm)	Lenght (mm)
001		1	70x130	6200
002		1	70x130	1618
003		1	70x130	4582
004		4	70x130	6200
005		2	70x130	1618
006		2	70x130	4582
007		8	70x130	3191
008		7	70x130	1709
009		1	70x130	2109
010		1	70x130	1718
011		1	70x130	5383
012		1	70x130	6200
013		1	70x130	3100
014		1	70x130	3100
015		4	70x130	6200
016		4	70x130	3100
017		15	70x130	1230
018		8	70x130	2190
019		1	70x130	1630
020		1	70x130	3200
021		1	70x130	3900
022		1	70x130	3235
023		20	70x130	3235
024		1	70x130	270
025		30	70x130	270

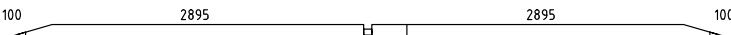
Teilleiste 2 871130

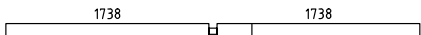
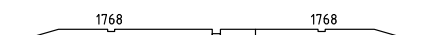
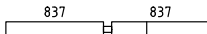
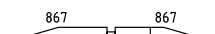
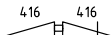
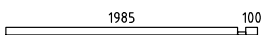
Pos			Profil (mm)	Lenght (mm)
026		1	70x130	6600
027		1	70x130	7100
028		1	70x65	7100
029		1	70x65	570
030		1	70x65	4032
031		15	70x130	570
032		1	70x130	4032
033		6	70x130	4032
034		1	70x130	4032
035		7	70x130	1281
036		7	70x130	1451
037		1	70x130	6200
038		1	70x130	6200
039		1	70x130	5409
040		12	70x121	421
041		1	70x130	3546
042		1	70x130	3606
043		1	70x130	1743
044		1	70x130	1803
045		1	70x120	902
046		1	70x65	6200
047		1	70x130	6200
048		6	70x130	6200
049		1	70x130	6200
050		7	70x130	4195

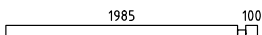
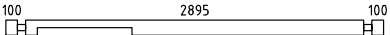
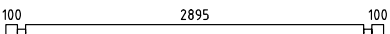
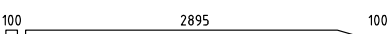
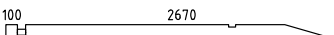
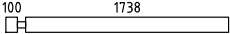
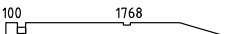
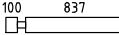
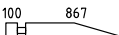

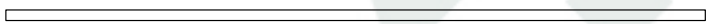
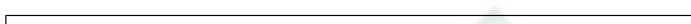

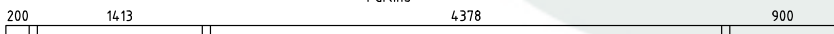



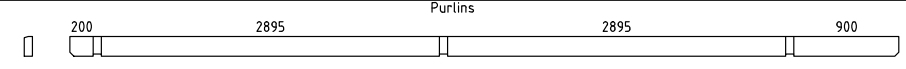

Teilleiste 3

871130

Pos			Profil (mm)	Lenght (mm)
051		7	70x130	1230
052		1	70x130	6200
053		1	70x130	6200
054		1	70x130	5409
055		1	70x130	3546
056		1	70x130	3606
057		1	70x130	1743
058		1	70x130	1803
059		1	70x120	902
060		2	70x65	2155
061		2	70x65	270
062		28	70x130	2155
063		2	70x130	3235
064		2	70x130	3235
065		2	70x130	3235
066		2	70x130	2840
067		2	70x130	1908
068		2	70x130	1938
069		2	70x130	1007
070		2	70x130	1037
071		2	70x120	586
GR2	GROUNDFRAME 	2	45x90	5990
GR1	GROUNDFRAME 	2	45x90	5900
FB1	FLOORBEAMS 	14	45x90	5900
PR1	Purlins 	2	70x170	7100











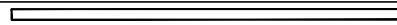



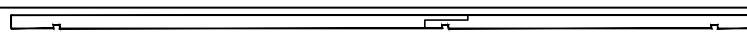

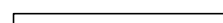

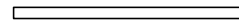



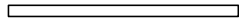
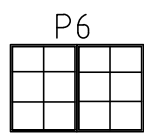
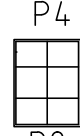
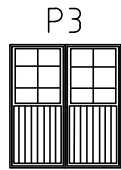
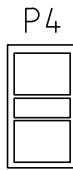

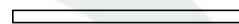

Teileliste 4

871130

Pos			Profil (mm)	Lenght (mm)
PR2			70x170	7100
	WINDOW 1290x996			2
	WINDOW 765x996			3
	DOOR 1588x2050			1
	DOOR 800x1900			2
1	Screws/Schrauben/Vis 5x100 mm- For fixing first row of wall logs /Fixierung des ersten Bohlenkranzes/Pour fixer les lamesde plancher 			6
2	Nails/Nägel/Clous 2.1x50 - For fixing floorboards/ Befestigung Fussbodenbretter/Pour fixer les lames de plancher 			495
3	Nails/Nägel/Clous 2.1x50 - For fixing roofboards/ Befestigung Dachbretter/Pour fixer les voliges 			550
4	Nails/Nägel/Clous 2.1x50 - For fixing floor edge trims/ Befestigung Fussleisten/Pour fixer les plinthes du plancher 			30
5	Nails/Nägel/Clous 2.1x50 - For fixing roofing felt fillet/ Befestigung giebelabschlussbrett/Pour fixer la latte de finition de la couverture 			20
6	Screws/Schrauben/Vis 3,5x50 mm- For fixing roof side boards and roof edge reinforcement Befestigung Traufenbretter und Traufenleisten Pour fixer les planches de rive et le tasseau de refront 			44
7	Screws/Schrauben/Vis 3,5x50 mm- For fixing fascia boards and diamonds/ Befestigung Giebelblende und Raute Pour fixer les planches de rive et le diamant 			28
8	Screws/Schrauben/Vis 3,5x50 mm- For fixing fwindow and door trims/ Befestigung Fenster und Türen/Pour fixer les croisillons des fenetres et des portes 			68
9	Metal storm Brace/Gewindestange/Tige filetee 10 mm 			6
10	Shim/Nuts/Mutter ,U-Scheibe/Ecrou/Rondelle 10 mm For fixing storm braces/ Pour fixer les anti tempete/ Für Sturmleisten Pour fixer les croisillons des fenetres et des portes  Metal storm Brace/Gewindestange/Tige filetee 10 mm KL1 M10 2,31 m 4 Screws 180 12 pcs. KL2 M10 3,14 m 1 Plastic caps 6 pcs. KL3 M10 3,02 m 1			6/6

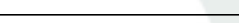
Teileliste 5

871130

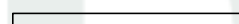
POS	ST.	B	H	L	ERKLÄRUNG		
FB1	Vt. spetsi					FLOORBEAMS	
F1	16,96m ²	28		2890		FUSSBODENBRETTER 67/51/42	
F2	12,67m ²	28		4373		FUSSBODENBRETTER 34/26/21	
F3	4,08m ²	28		1407		FUSSBODENBRETTER 34/26/21	
PR	4	70	170	7100		ROOFBEAMS	
RB1	48,02m ²	20		3382		Dachbretter 164/125/103	
R1	4	20	120	3550	Vaata katuse kaldenurka 	Frontboard	
R2	4	45	65	3550	Vaata katuse kaldenurka 	Frontboard fixing board	
R3	4	20	120	3600	Vaata katuse kaldenurka 	Girders facade	
R4	4	20	90	3600		Topboard	
WN29	2	1290	996		  <p>Sliding stats 30x30x1900 mm - 2 pcs. 30x30x800 mm - 2 pcs.</p>		
WN07	3	765	996				
DR15	1	1588	2050		 <p>External door</p>  <p>Internal door</p>		
DR08	2	800	1900				
P1	43m	20	40			Floor edge trim	
P2	2+2	20	90	2030		Fixing boards for DR15	
P3	1+1	20	90	1890		Fixing boards for DR15	
P4	28	20	90	1100		Fixing boards for DR08, WN29, WN07	
P5	4+4	20	90	1880		Fixing boards for DR08	
P6	2+2	20	90	1590		Fixing boards for WN29	
P7	2+2	20	90	1250		Fixing boards for WN29	
P8	3+3	20	90	725		Fixing boards for WN07	

Detailzeichnungen 871130

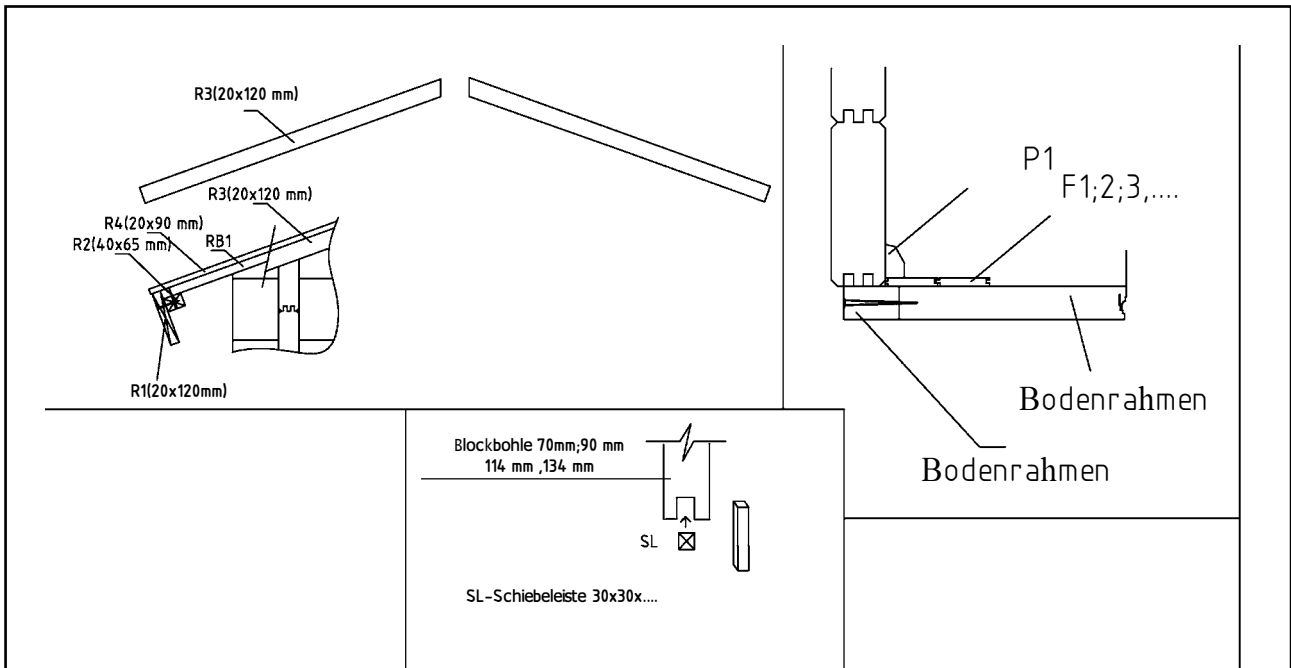

Dichtungssystem der Blockbohlen

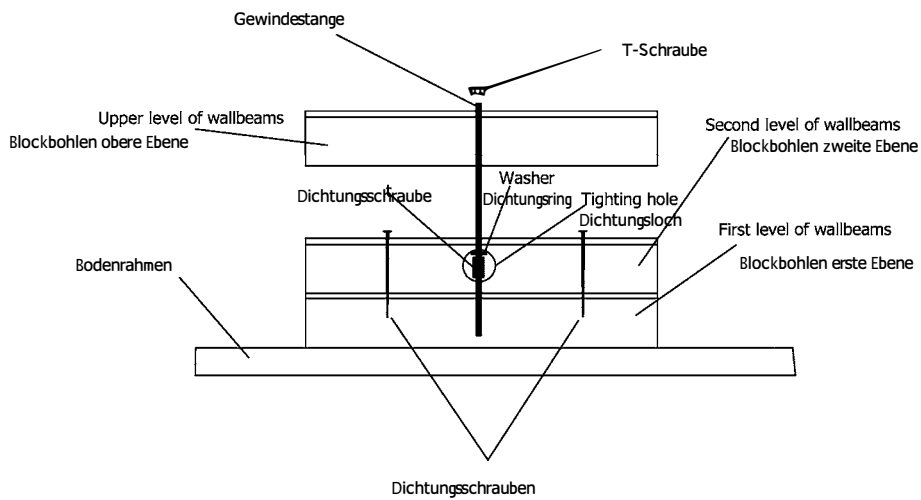

Wandplan 1 und 2

871130

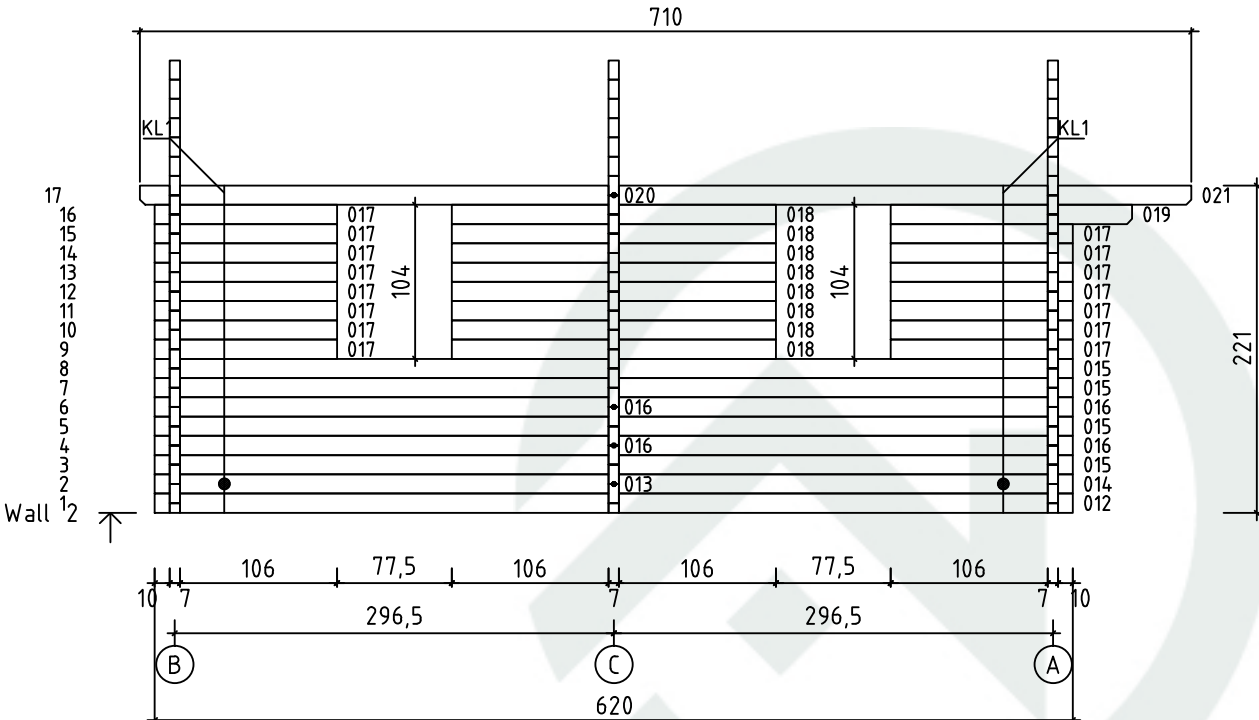
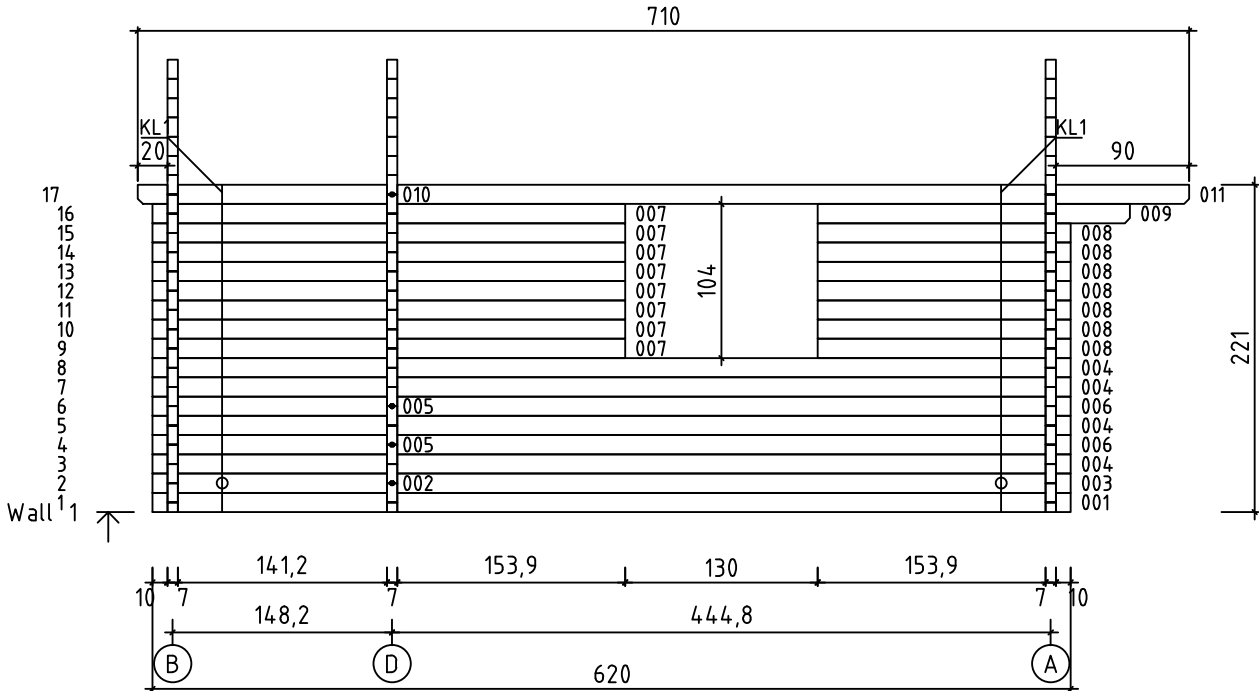

Wandplan 3 871130

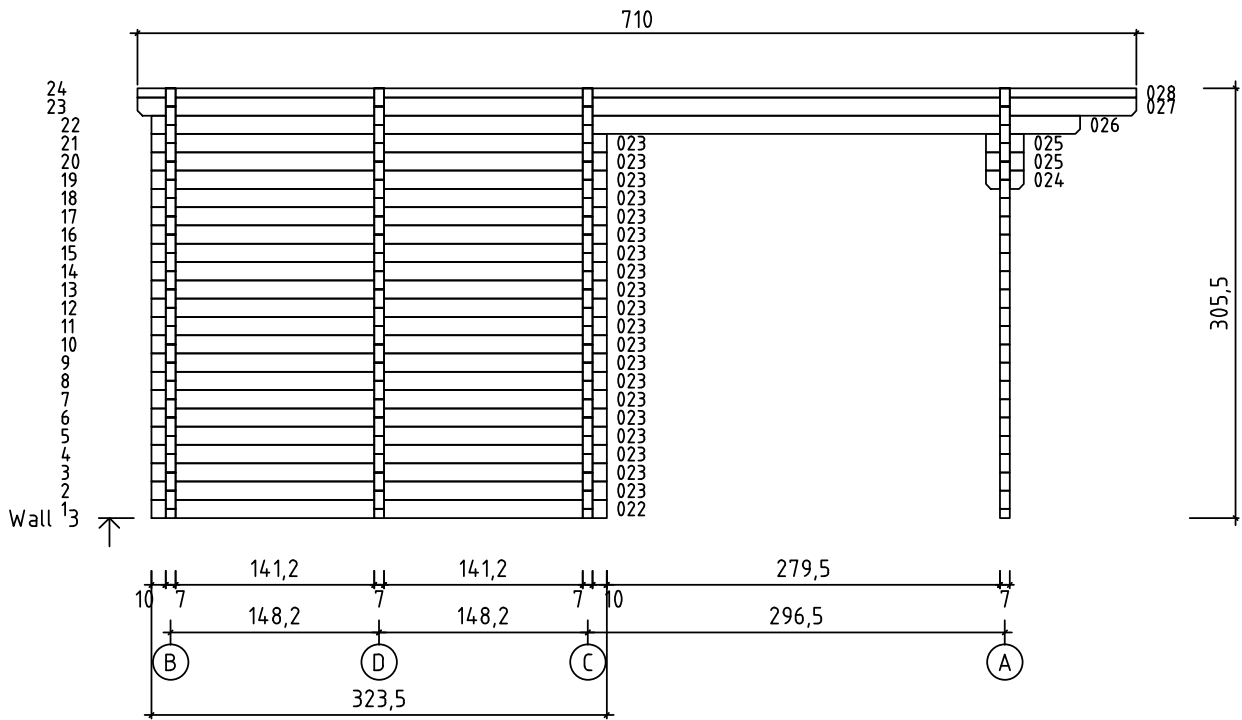

Wandplan A und B 871130

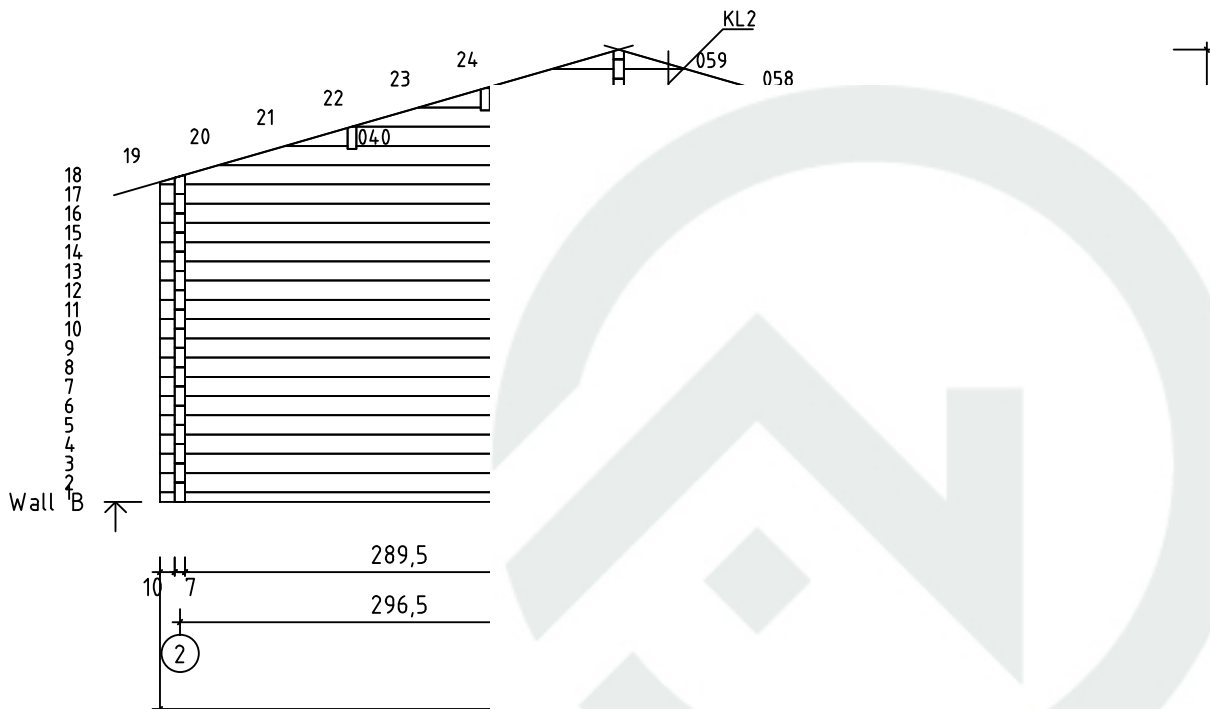
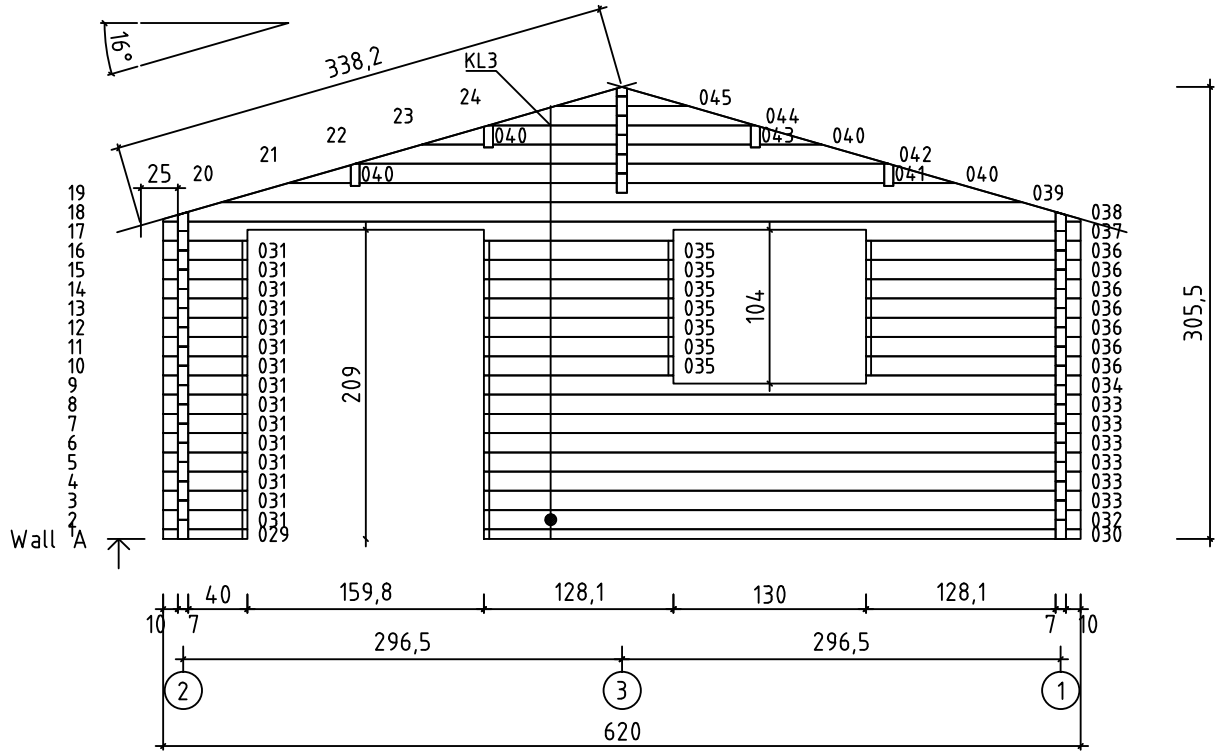

Wandplan C und D 871130

