

# Technische Daten: Art.-Nr.: 870640

Wandaußenmaß: 500 x 500 cm

Bohlenstärke: 70 mm



Nordkap 70-D, durch Kunden farblich endbehandelt.

Kontrolliert durch:

Achtung: Alle angegebenen Maße sind ca.-Maße!

# 3D-Darstellung und Grundriss 870640

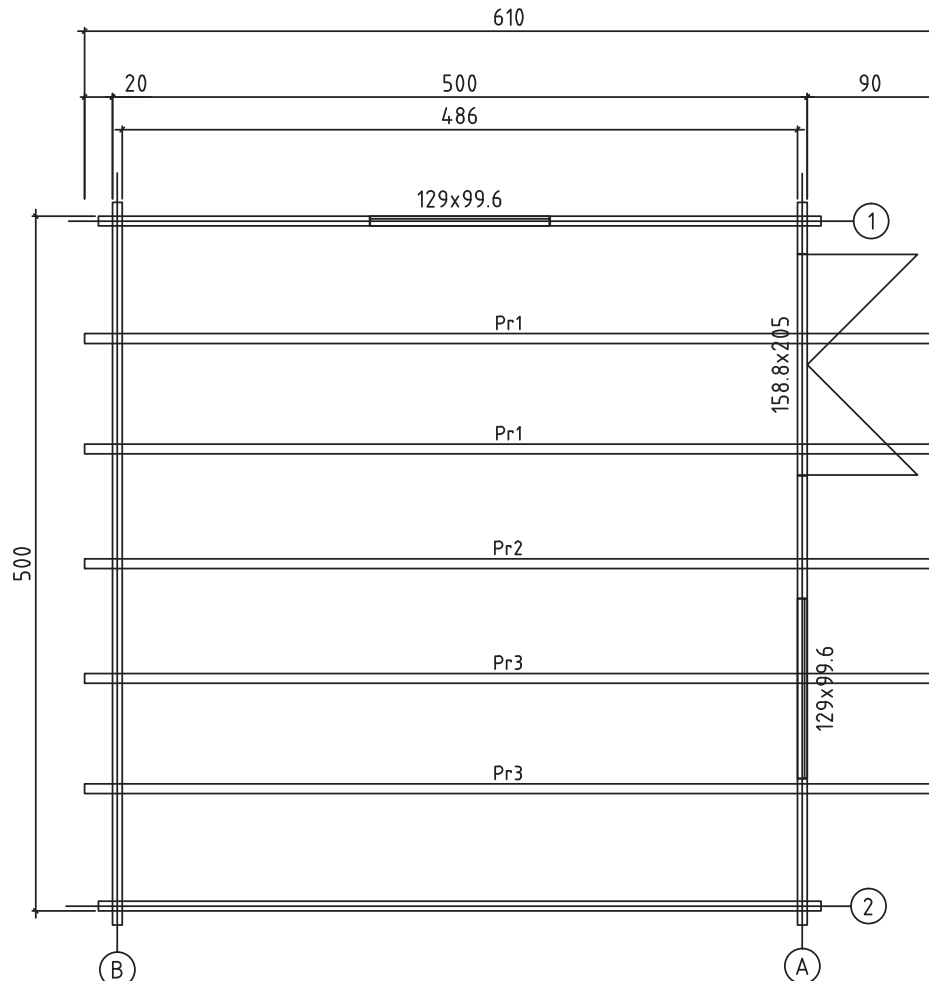
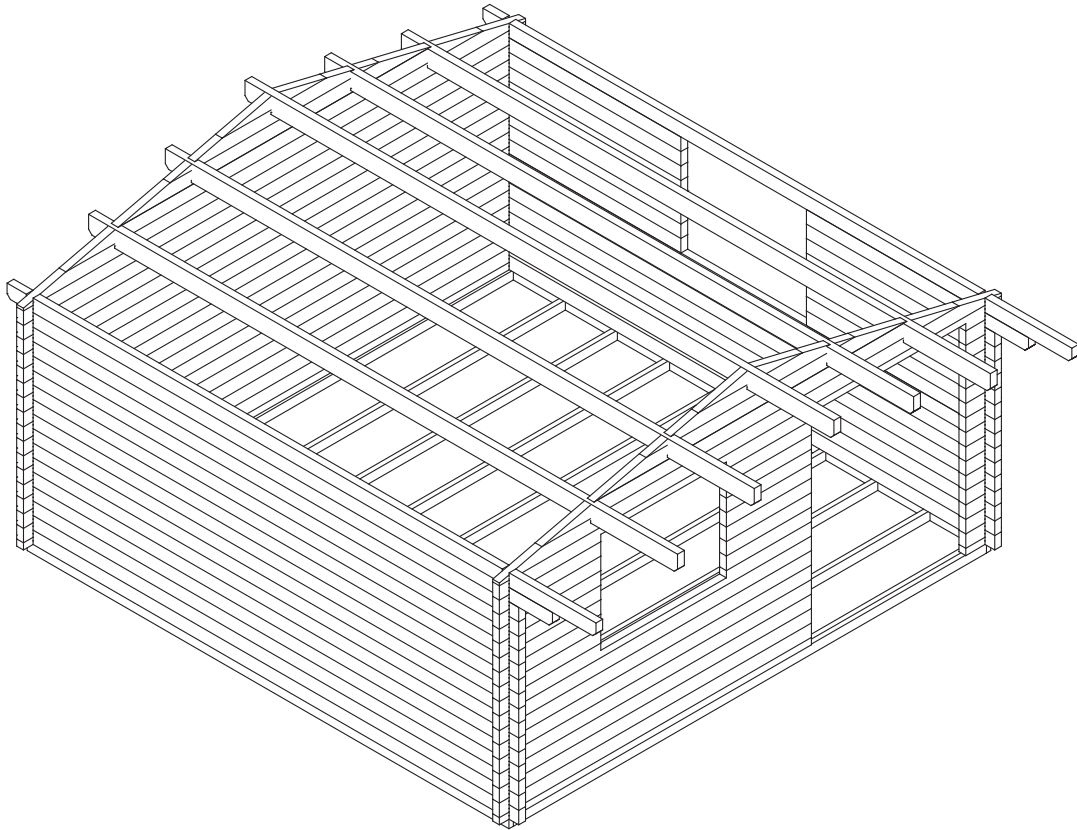





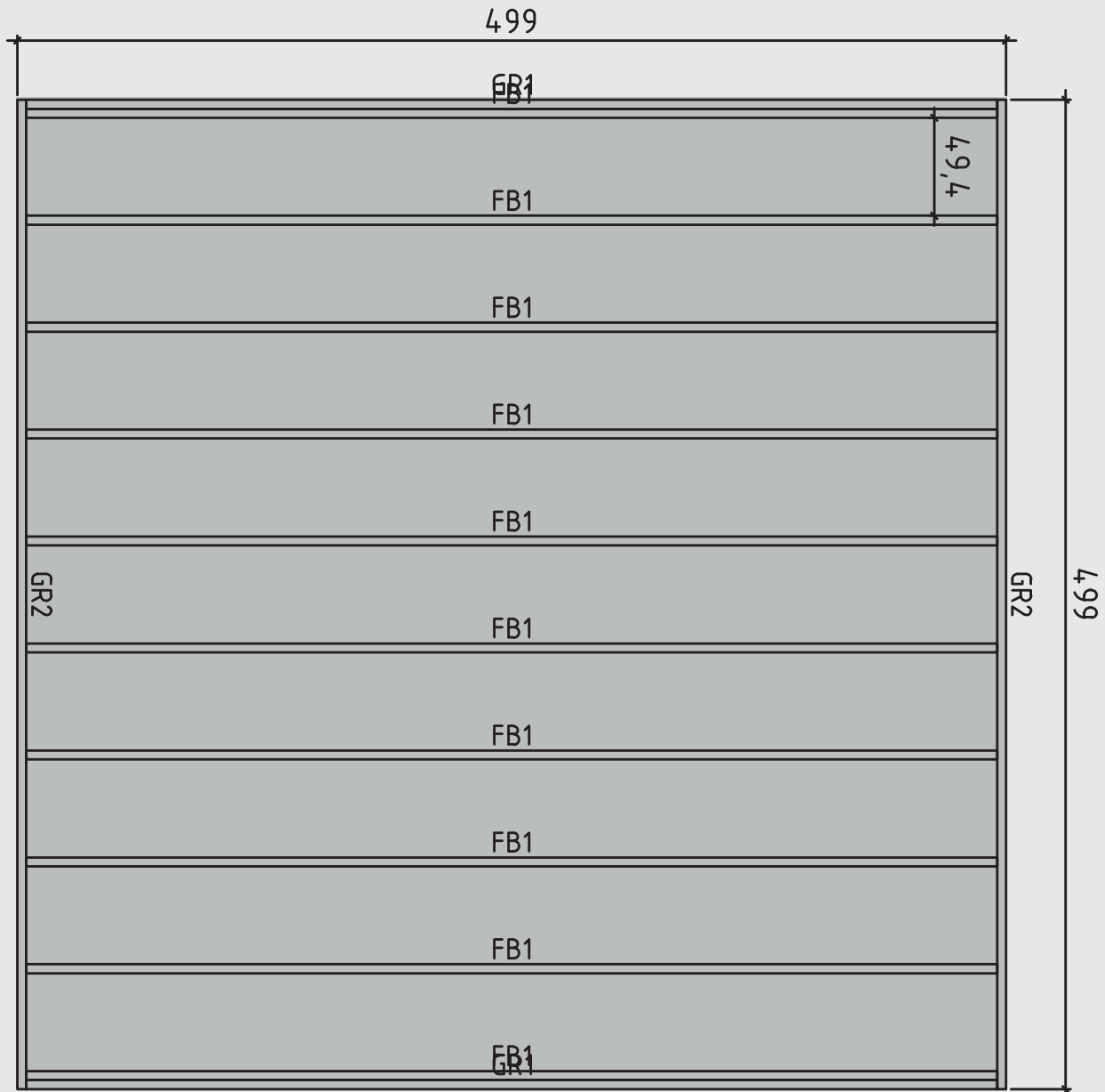





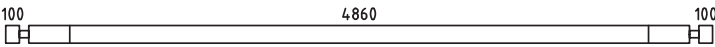
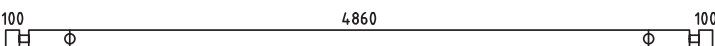

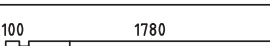
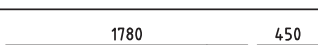
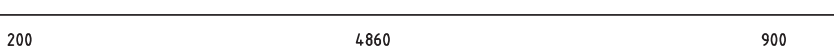
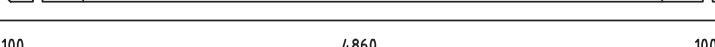
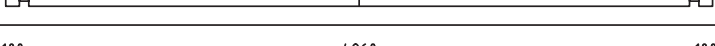
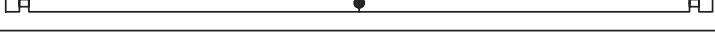
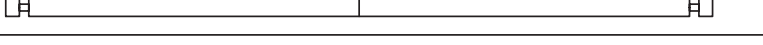
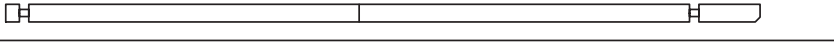
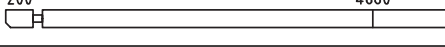

# Lagerholzplan und Fundamentplan 870640

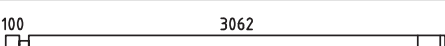
Wir empfehlen als Fundament für Ihr Gartenhaus eine vollflächig,  
festgegründete gepflasterte oder betonierte Fläche.  
Wahlweise ist auch ein Punkt- oder Streifenfundament möglich.

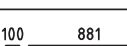

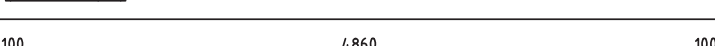

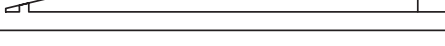









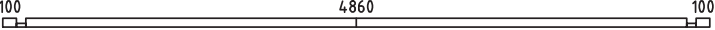
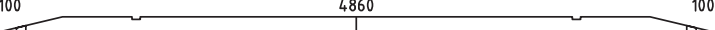
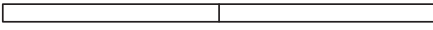
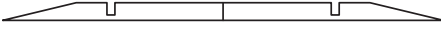

# Teileliste 1

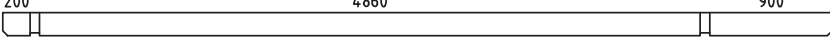
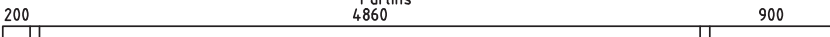
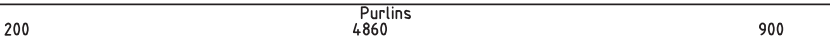
## 870640

Pos			Profil (mm)	Lenght (mm)
001		1	70x130	5200
002		1	70x130	5200
003		6	70x130	5200
004		15	70x130	1950
005		1	70x130	2300
006		1	70x130	6100
007		1	70x130	5200
008		2	70x130	5200
009		28	70x130	5200
010		1	70x130	5550
011		1	70x130	6100
012		1	70x65	3232
013		1	70x65	370
014		1	70x130	3232
015		15	70x130	370
016		6	70x130	3232
017		1	70x130	3232
018		7	70x130	1051
019		7	70x130	881
020		1	70x130	5200
021		1	70x130	5200
022		7	70x123	510
023		1	70x130	3180
024		1	70x130	3240
025		4	70x54	225

# Teileliste 2



















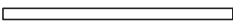

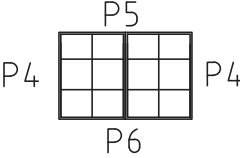
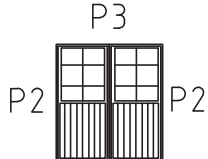
## 870640

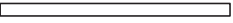
Pos			Profil (mm)	Lenght (mm)
026			70x130	1650
027			70x123	510
028			70x65	5200
029			70x130	5200
030			70x130	3180
031			70x130	3240
032			70x130	1650
GR2		GROUNDFRAME	45x90	4990
GR1		GROUNDFRAME	45x90	4900
FB1		FLOORBEAMS	45x90	4900
Pr1		Purlins 4860	70x170	6100
Pr2		Purlins 4860	70x170	6100
Pr3		Purlins 4860	70x170	6100
	WINDOW 1290x996			2
	DOOR 1588x2050			1
1	Screws/Schrauben/Vis 5x100 mm- For fixing first row of wall logs /Fixierung des ersten Bohlenkranzes/Pour fixer les lamesde plancher			6
2	Nails/Nägel/Clous 2.1x50 - For fixing floorboards/ Befestigung Fussbodenbretter/Pour fixer les lames de plancher			495
3	Nails/Nägel/Clous 2.1x50 - For fixing roofboards/ Befestigung Dachbretter/Pour fixer les voliges			550
4	Nails/Nägel/Clous 2.1x50 - For fixing floor edge trims/ Befestigung Fussleisten/Pour fixer les plinthes du plancher			30
5	Nails/Nägel/Clous 2.1x50 - For fixing roofing felt fillet/ Befestigung giebelabschlussbrett/Pour fixer la latte de finition de la couverture			20
6	Screws/Schrauben/Vis 3,5x50 mm- For fixing roof side boards and roof edge reinforcement Befestigung Traufbretter und Traufleisten Pour fixer les planches de rive et le tasseau de refront			44
7	Screws/Schrauben/Vis 3,5x50 mm- For fixing fascia boards and diamonds/ Befestigung Giebelblende und Raute Pour fixer les planches de rive et le diamant			28
8	Screws/Schrauben/Vis 3,5x50 mm- For fixing fwindow and door trims/ Befestigung Fenster und türen/ Pour fixer les croisillons des fenetres et des portes			68

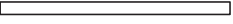

# Teileliste 4

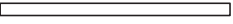
## 870640

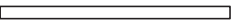
POS	ST.	B	H	L	ERKLÄRUNG
FB1	Vt. spetsi				 FLOORBEAMS
F1	23,61m <sup>2</sup>	28		4855	 FUSSBODENBRETTER 55/42/35
PR	5	70	170	6100	 ROOFBEAMS
RB1	34,52m <sup>2</sup>	20		2830	 Dachbretter 138/108/88
R1	4	20	120	3050	<i>Vaata katuse kaldenurka</i>  Frontboard 
R2	4	45	65	3050	<i>Vaata katuse kaldenurka</i>  Frontboard fixing board 
R3	4	20	120	3000	<i>Vaata katuse kaldenurka</i>  Girders facade 
R4	4	20	90	3000	 Topboard 
WN29	2	1290	996		
DR15	1	1588	2050	 <p>Sliding slats 30x30x1900 mm - 2 pcs. 30x30x800 mm - 2 pcs.</p>	
P1	21m	20	40		 Floor edge trim
P2	2+2	20	90	2030	 Türleiste DR15 
P3	1+1	20	90	1890	 Türleiste DR15 
P4	4+4	20	90	1100	 Fensterleiste WN29 
P5	2+2	20	90	1590	 Fensterleiste WN29 
P6	2+2	20	90	1250	 Fensterleiste WN29 

# Detailzeichnungen 870640

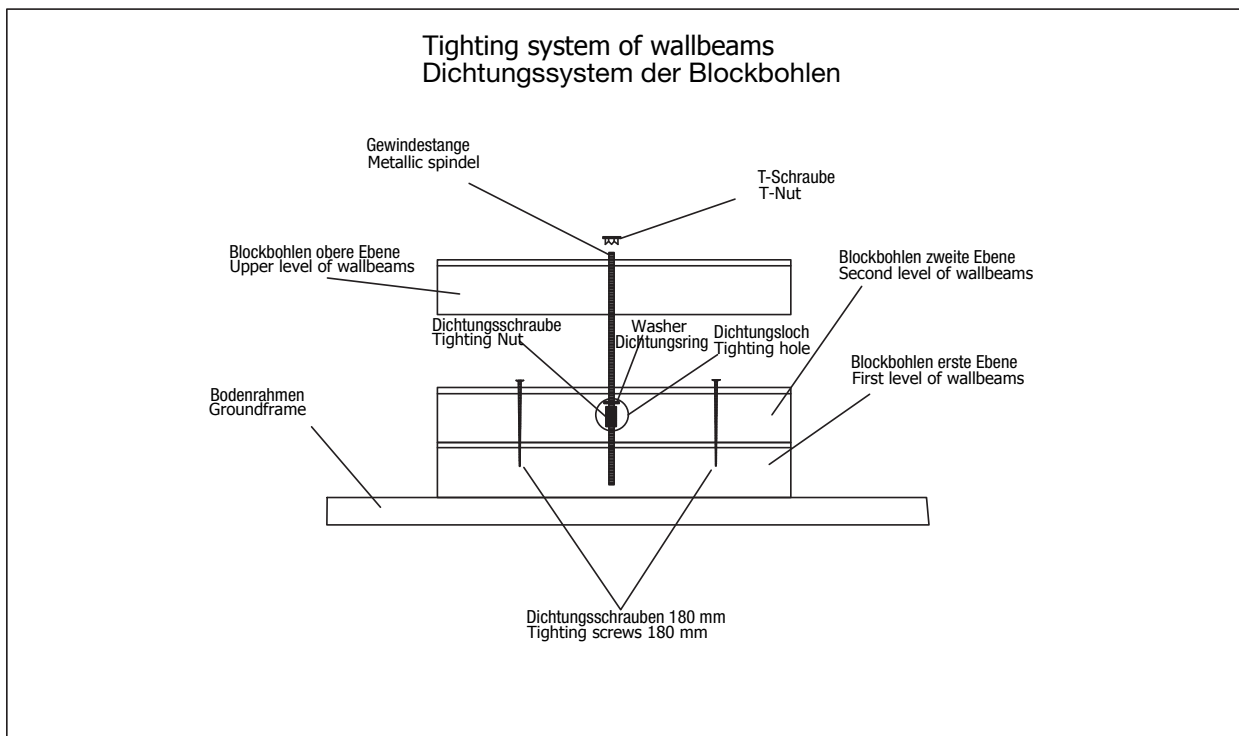
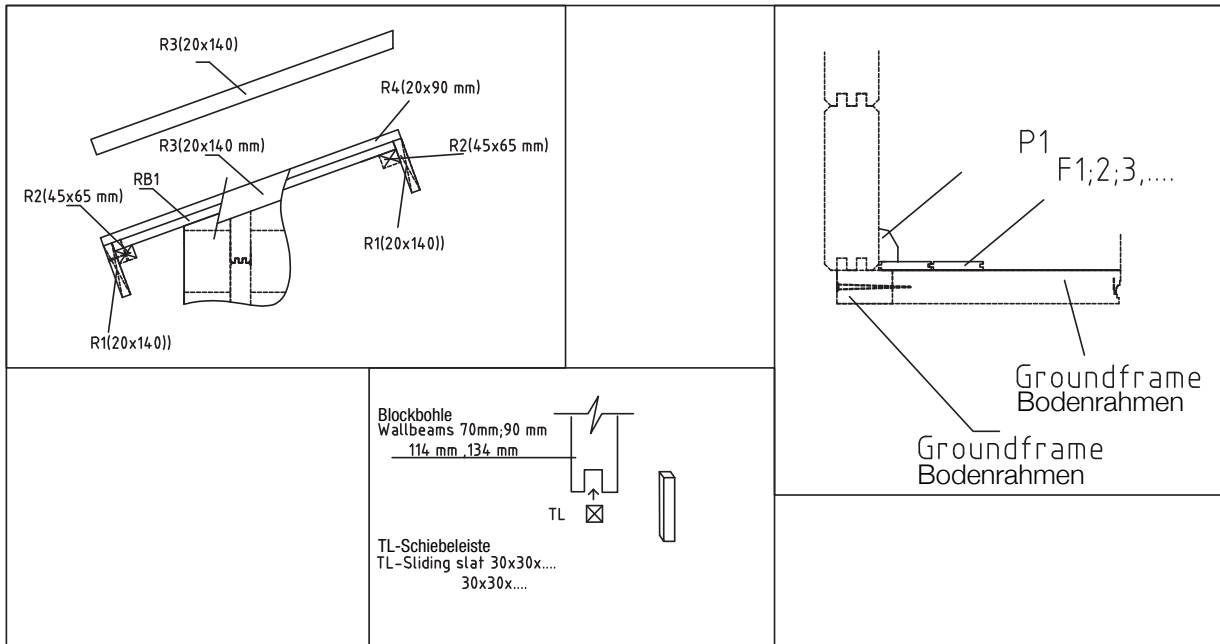





# Wandplan A und B 870640

