

**Technische Daten: Art.-Nr.: 870670**

**Wandaußenmaß: 500 x 400 cm**

**Bohlenstärke: 70 mm**



Nordkap 70-L, durch Kunden farblich endbehandelt.

Kontrolliert durch:

Empty box for signature or name.

Achtung: Alle angegebenen Maße sind ca.-Maße!

# 3D-Darstellung und Grundriss 870670

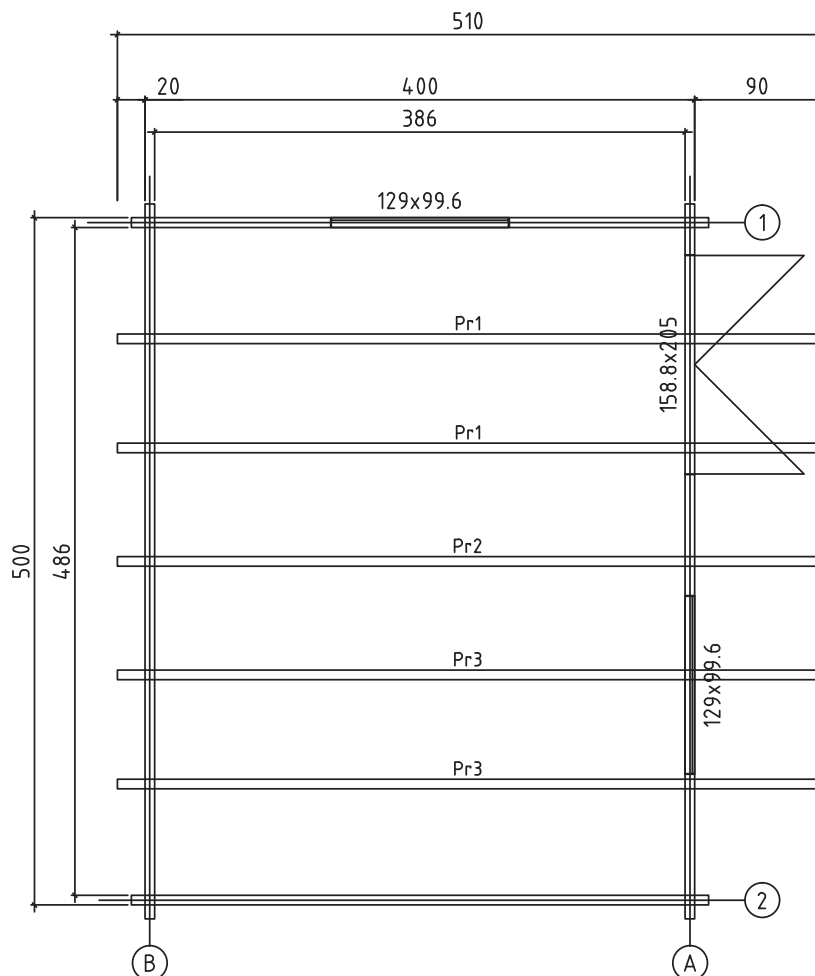
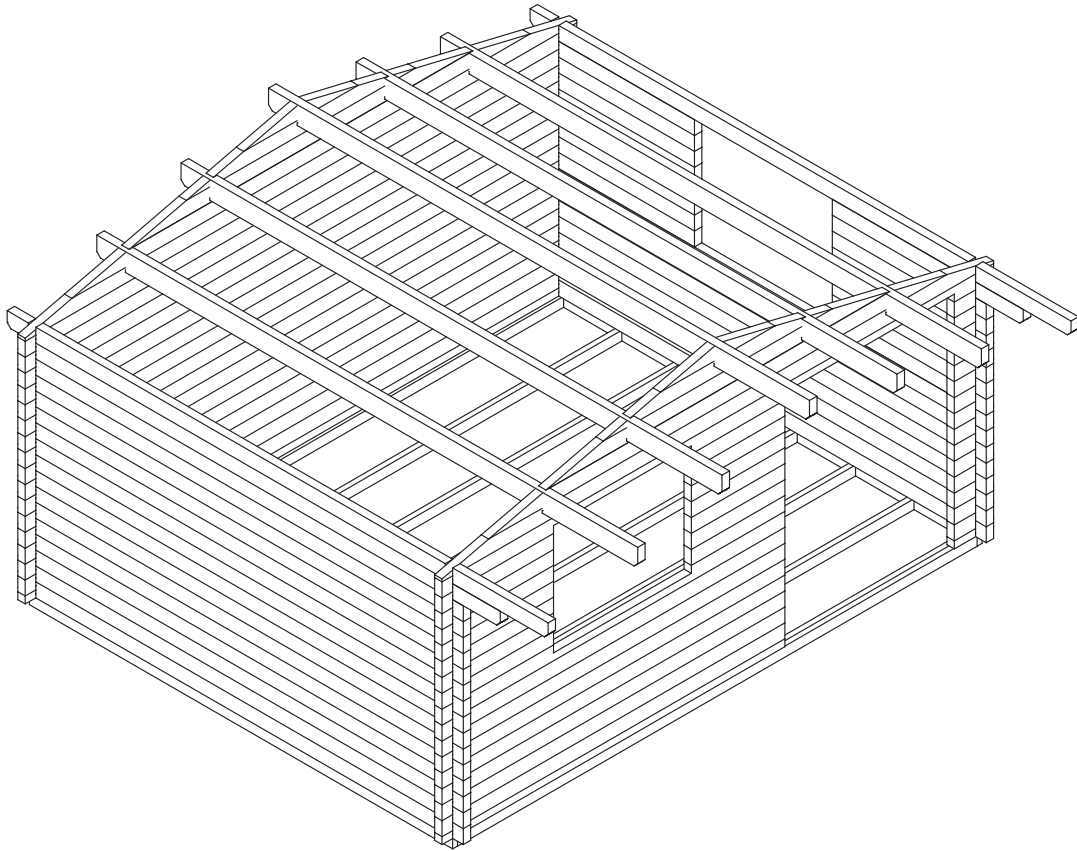





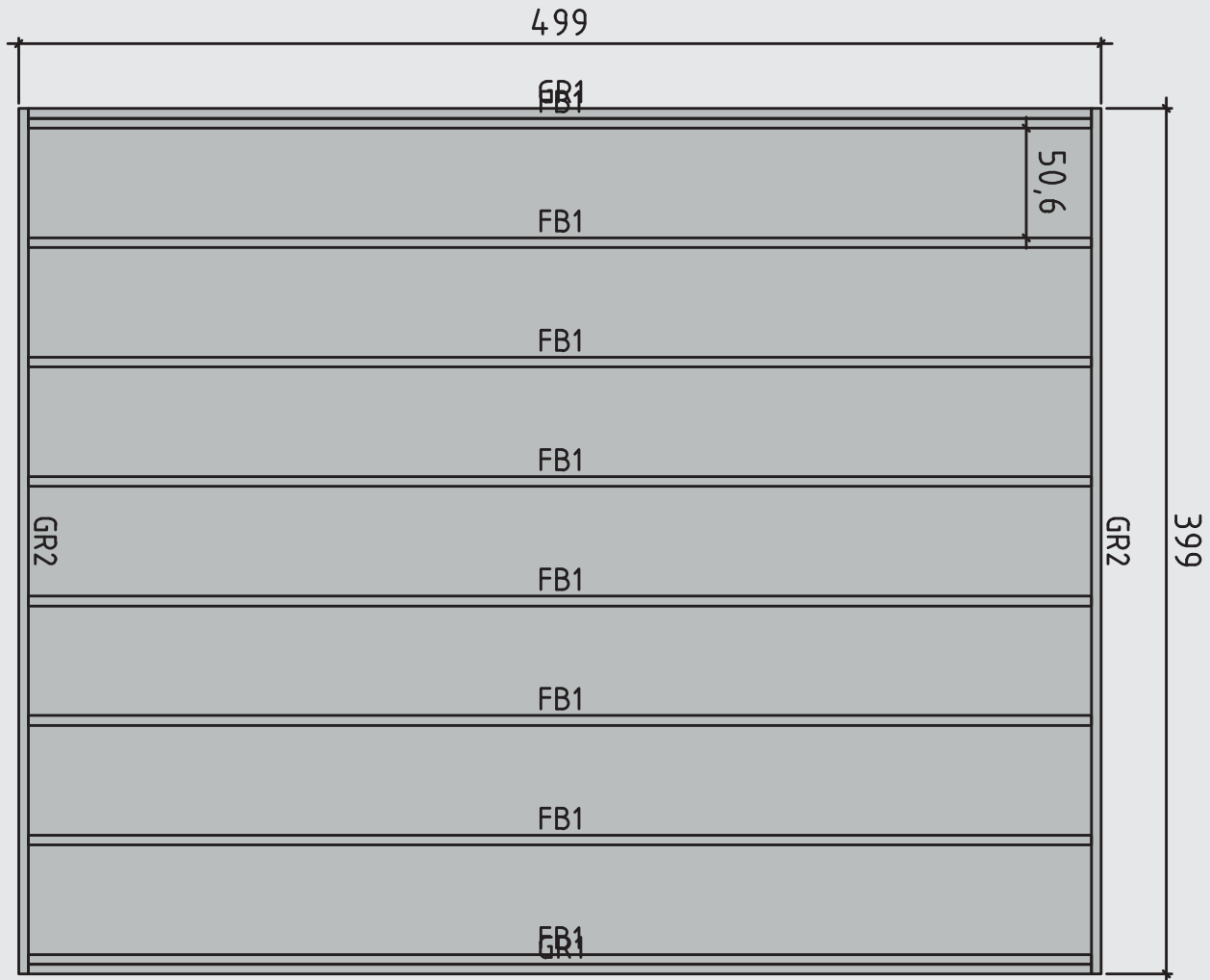





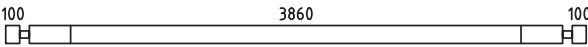
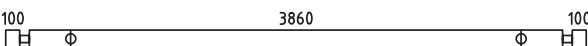
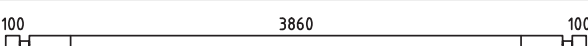
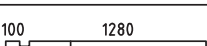
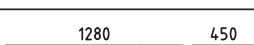
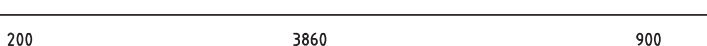
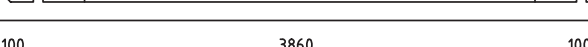
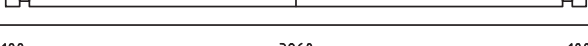
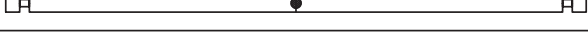
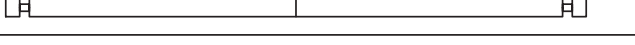
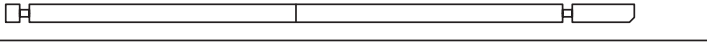
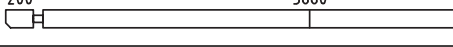

# Lagerholzplan und Fundamentplan 870670

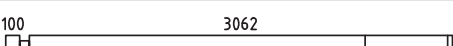
Wir empfehlen als Fundament für Ihr Gartenhaus eine vollflächig,  
festgegründete gepflasterte oder betonierte Fläche.  
Wahlweise ist auch ein Punkt- oder Streifenfundament möglich.

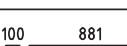

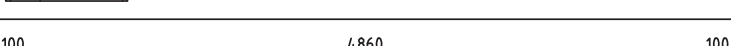
# Teileliste 1

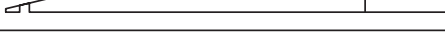
## 870670

Pos			Profil (mm)	Lenght (mm)
001		1	70x130	4200
002		1	70x130	4200
003		6	70x130	4200
004		15	70x130	1450
005		1	70x130	1800
006		1	70x130	5100
007		1	70x130	4200
008		1	70x130	4200
009		13	70x130	4200
010		1	70x130	4550
011		1	70x130	5100
012		1	70x65	3232
013		1	70x65	370
014		1	70x130	3232
015		15	70x130	370
016		6	70x130	3232
017		1	70x130	3232
018		7	70x130	1051
019		7	70x130	881
020		1	70x130	5200
021		2	70x130	5200
022		8	70x123	510
023		2	70x130	3180
024		2	70x130	3240
025		4	70x54	225



















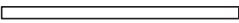

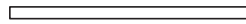
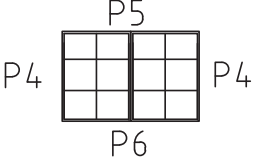
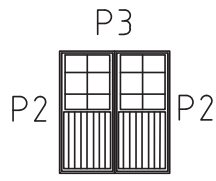

# Teileliste 2

## 870670

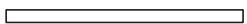
Pos			Profil (mm)	Lenght (mm)
026			70x130	1650
027			70x65	5200
028			70x130	5200
029			70x130	5200
GR1	GROUNDFRAME 		45x90	4900
GR2	GROUNDFRAME 		45x90	3990
FB1	FLOORBEAMS 		45x90	4900
Pr1	Purlins 		70x170	5100
Pr2	Purlins 		70x170	5100
Pr3	Purlins 		70x170	5100
	WINDOW 1290x996			
	DOOR 1588x2050			
1	Screws/Schrauben/Vis 5x100 mm- For fixing first row of wall logs /Fixierung des ersten Bohlenkranzes/Pour fixer les lames de plancher			6
2	Nails/Nägel/Clous 2.1x50 - For fixing floorboards/ Befestigung Fussbodenbretter/Pour fixer les lames de plancher			495
3	Nails/Nägel/Clous 2.1x50 - For fixing roofboards/ Befestigung Dachbretter/Pour fixer les voliges			550
4	Nails/Nägel/Clous 2.1x50 - For fixing floor edge trims/ Befestigung Fussleisten/Pour fixer les plinthes du plancher			30
5	Nails/Nägel/Clous 2.1x50 - For fixing roofing felt fillet/ Befestigung giebelabschlussbrett/Pour fixer la latte de finition de la couverture			20
6	Screws/Schrauben/Vis 3,5x50 mm- For fixing roof side boards and roof edge reinforcement Befestigung Traufenbretter und Traufenleisten Pour fixer les planches de rive et le tasseau de refront			44
7	Screws/Schrauben/Vis 3,5x50 mm- For fixing fascia boards and diamonds/ Befestigung Giebelblende und Raute Pour fixer les planches de rive et le diamant			28
8	Screws/Schrauben/Vis 3,5x50 mm- For fixing fwindow and door trims/ Befestigung Fenster und türen/ Pour fixer les croisillons des fenetres et des portes			68
9	Metal storm Brace/Gewindestange/Tige filetee 10 mm			5
10	Shim;Nuts/Mutter ,U-Scheibe/Ecrou;Rondelle 10 mm For fixing storm braces/ Pour fixer les anti tempete/ Für Sturmleisten Pour fixer les croisillons des fenetres et des portes Metal storm Brace/Gewindestange/Tige filetee 10 mm KLI M10 2,77 m 2 Screws 180 10pcs. KL2 M10 2,31 m 3 Plastic caps 5 pcs.			5/5

# Teileliste 3

## 870670

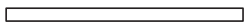
POS	ST.	B	H	L	ERKLÄRUNG		
FB1	Vt. spetsi					FLOORBEAMS	
F1	18,75m <sup>2</sup>	28		3855		FUSSBODENBRETTER 55/42/35	
PR	5	70	170	5100		ROOFBEAMS	
RB1	28,86m <sup>2</sup>	20		2830		Dachbretter 138/108/88	
R1	2	20	120	5100		Frontboard	
R2	2	45	65	5100		Frontboard fixing board	
R3	4	20	120	3000		Girders facade	
R4	4	20	90	3000		Topboard	
WN29	2	1290	996				
DR15	1	1588	2050		 <p>Sliding slats 30x30x1900 mm - 2 pcs. 30x30x800 mm - 2 pcs.</p>		
P1	19m	20	40			Floor edge trim	
P2	2+2	20	90	2030		Türleiste DR15	
P3	1+1	20	90	1890		Türleiste DR15	
P4	4+4	20	90	1100		Fensterleiste WN29	
P5	2+2	20	90	1590		Fensterleiste WN29	
P6	2+2	20	90	1250		Fensterleiste WN29	

# Detailzeichnungen 870670

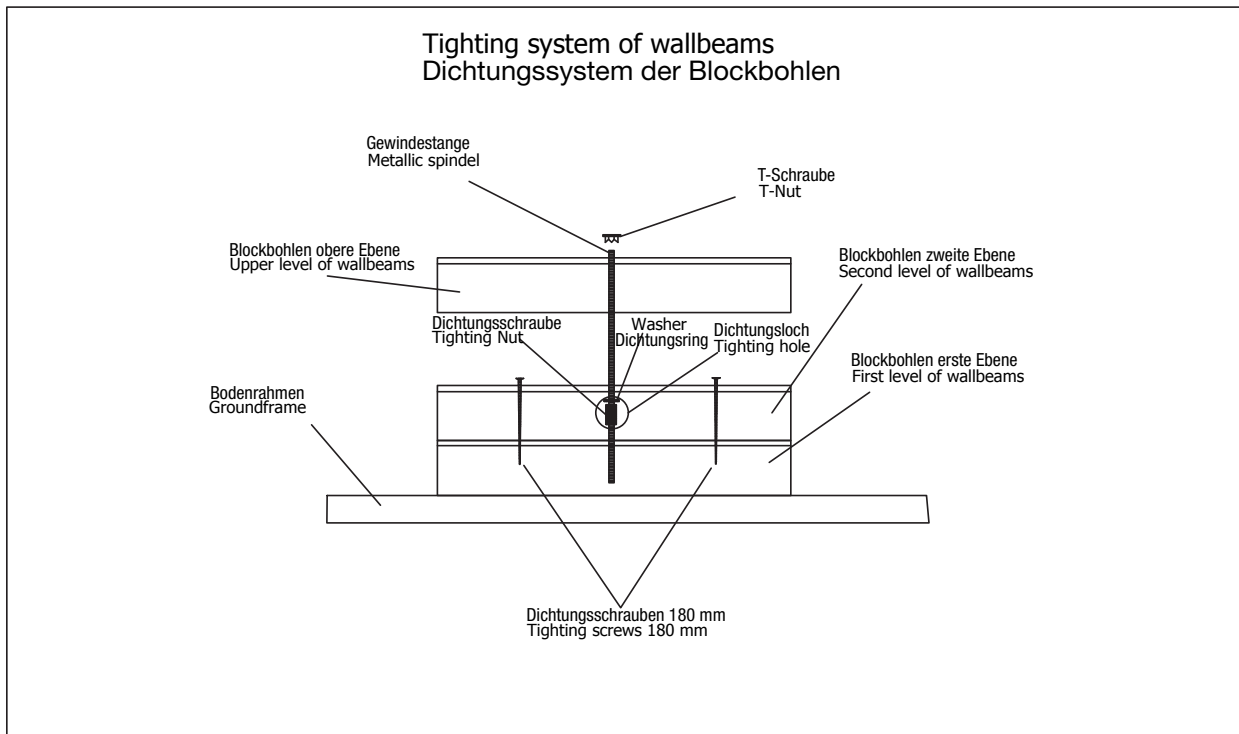
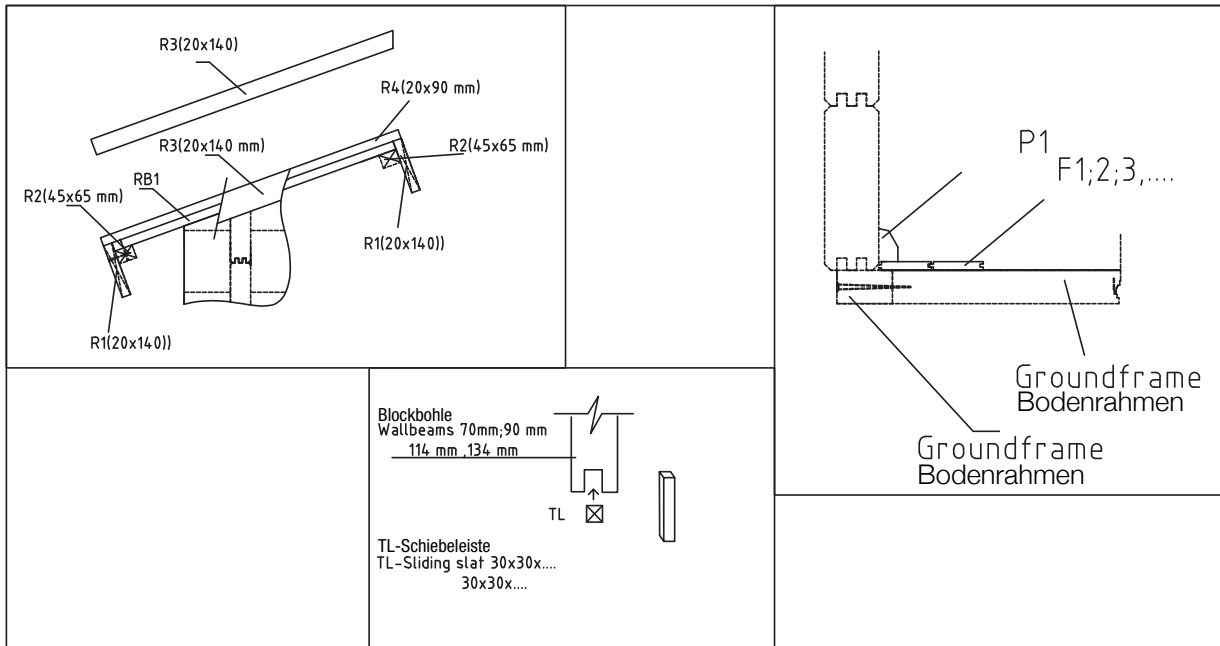

# Wandplan 1 und 2 870670

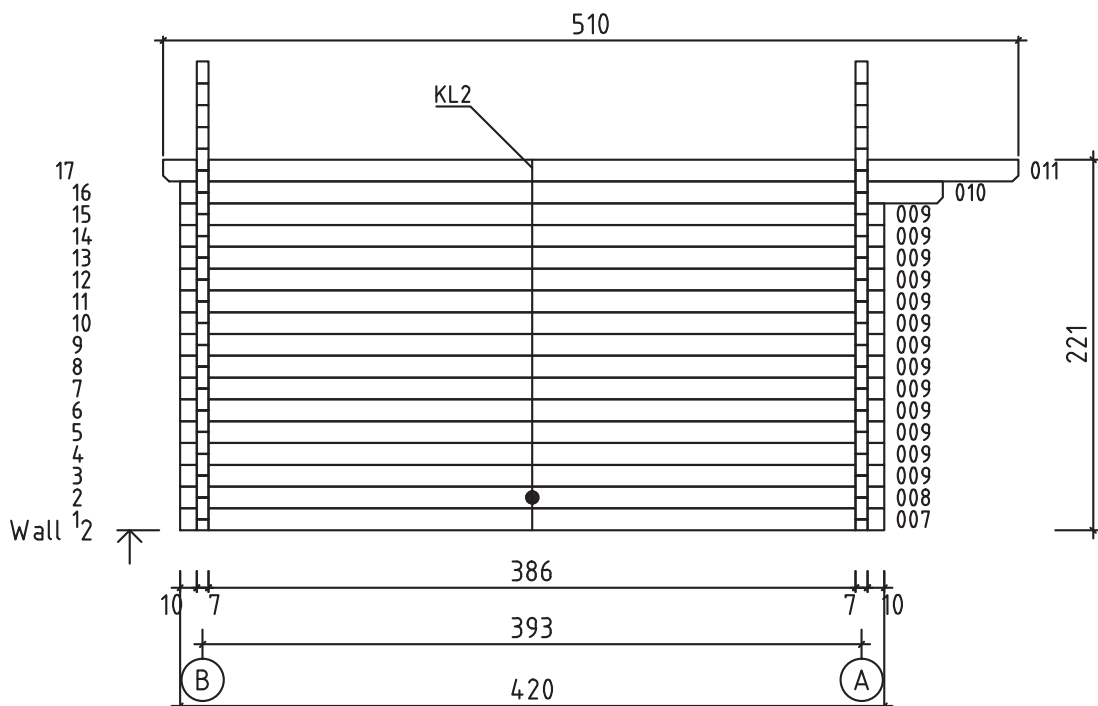
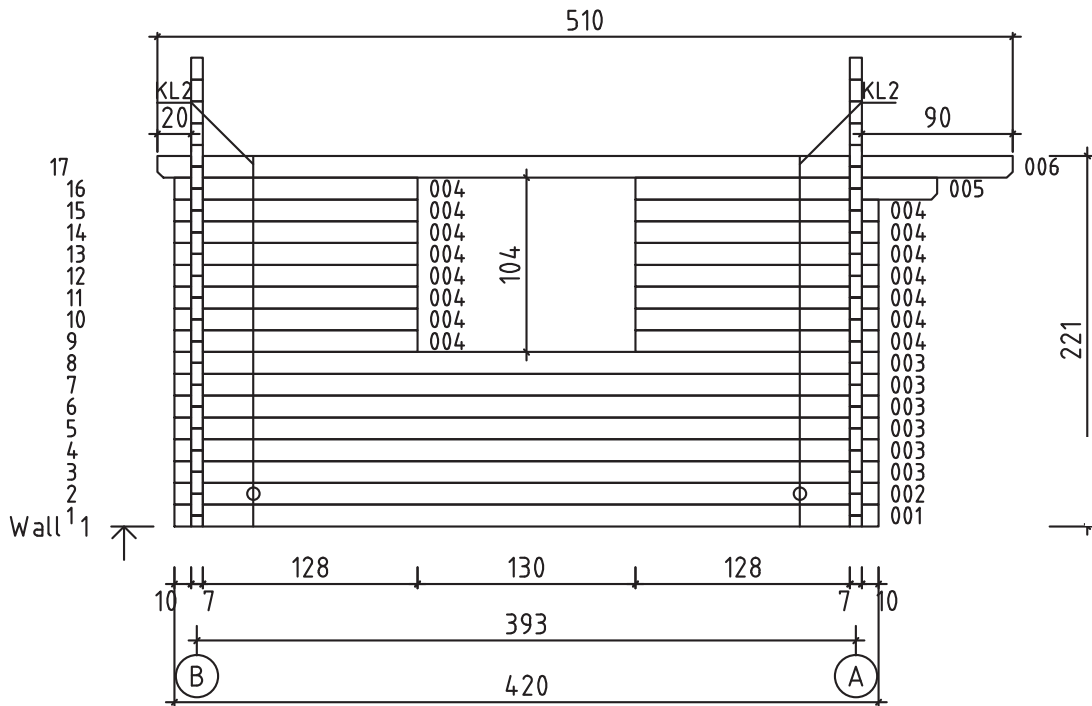



# Wandplan A und B 870670

